

# SEATING LOUNGE COLLECTION

April 2024 Price List

**AIS**

**PRODUCT INFORMATION**

Portfolio . . . . . 4

Product Details . . . . . 8

Finish Options. . . . . 9

COM Yardage Requirements . . . . . 11

Laminate Woodgrain Direction . . . . . 18

Configurable Model Diagrams . . . . . 19

**AIS LOUNGE**

**CHIC**

Chic Lounge Product Information. . . . . 20

Chic Lounge Models and Options . . . . . 21

Chic Tables Product Information . . . . . 22

Chic Tables Models and Options . . . . . 23

**JUGGLE**

Juggle Seating Product Information . . . . . 24

Juggle Seating Models and Options . . . . . 25

**HAKR**

Hakr Mobile Lounge Product Information . . . . . 26

Hakr Mobile Lounge Models and Options . . . . . 27

Hakr Modular Lounge Product Information . . . . . 28

Hakr Modular Lounge Models and Options . . . . . 29

Hakr Modular Lounge Tables Product Information . . . . . 31

Hakr Modular Lounge Tables Models and Options . . . . . 32

Hakr Lounge with Ledge Product Information . . . . . 33

Hakr Lounge with Ledge Tables Models and Options . . . . . 34

Hakr Privacy Lounge Product Information . . . . . 35

Hakr Privacy Lounge Models and Options . . . . . 36

Hakr Full Privacy Lounge Models and Options . . . . . 37

Hakr Benches & Ottomans Product Information . . . . . 38

Hakr Benches & Ottomans Models and Options . . . . . 39

**NV LOUNGE**

NV Lounge Product Information . . . . . 40

NV Lounge Models and Options . . . . . 41

**SOFT LOUNGE**

Soft Lounge Product Information . . . . . 43

Soft Lounge Product Details . . . . . 44

Soft Lounge Models and Options. . . . . 45

Soft Mobile Lounge Product Information . . . . . 46

Soft Mobile Lounge Models and Options. . . . . 47

Soft Modular Lounge Product Information . . . . . 48

Soft Modular Lounge Models and Options . . . . . 49

Soft Privacy & Full Privacy Lounge Product Information . . . . . 50

Soft Privacy & Full Privacy Lounge Models and Options . . . . . 51

Soft Benches & Ottomans Product Information . . . . . 52

Soft Benches & Ottomans Models and Options . . . . . 53

**PRISMA**

Prisma Tables Product Information . . . . .54  
 Prisma Tables Models and Options . . . . .55

**LB LOUNGE**

LB Lounge Product Information . . . . .56  
 LB Lounge 1-Seater (2 Cushion) Models and Options . . . . .57  
 LB Lounge 2-Seater (4 Cushion) Models and Options . . . . .58  
 LB Lounge 3-Seater (6 Cushion) Models and Options . . . . .59  
 LB Lounge Backless Units Models and Options . . . . .60  
 LB Lounge Corner Units (3-Cushion) Models and Options . . . . .61  
 LB Ledges. . . . .62  
 LB Lounge Corner Units (3-Cushion) and Specification Guide . . . . .63  
 LB Ottomans Models and Options . . . . .64

**LB LOUNGE TABLES**

LB Lounge Corner and End Tables . . . . .65

**CHATHAM COVE**

Chatham Cove Product Information . . . . .66  
 Chatham Cove 2-Sided Models and Options . . . . .67  
 Chatham Cove 3-Sided Models and Options . . . . .68  
 Chatham Cove Inserts and Specification Guide . . . . .69

**VOLKER**

Volker Cubes and Nesting Table Product Information . . . . .70  
 Volker Cube Models and Nesting Table. . . . .71

**ANCILLARY TABLES**

Laptop Table and Sit to Stand Mobile Desk . . . . .72

**WARRANTY & TERMS AND CONDITIONS**

For Warranty & Terms and Conditions please visit:  
<https://aiscmsprod.blob.core.windows.net/infocenter/AISTermsWarranty.pdf>

**Portfolio**

**CHIC LOUNGE**



**Chic Club Chair**  
Non-Configurable or Configurable  
33" Wide



**Chic 2-Seater**  
Non-Configurable or Configurable  
53" Wide



**Chic 3-Seater**  
Non-Configurable or Configurable  
73" Wide



**Chic Side Table**  
21" Wide



**Chic 2-Seater Table**  
42" Wide

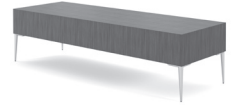

**Chic 3-Seater Table**  
62" Wide

**JUGGLE CHAIRS**



**Juggle Chair, Cross Wire Base**



**Juggle Chair, 4-Leg Swivel Base with Auto Return**



**Juggle Chair, 5-Star Swivel Base on Casters**

**HAKR LOUNGE**



**Hakr Mobile Lounge**  
Non-Configurable or Configurable  
32.5" Wide



**Hakr Mobile Lounge w/Tablet (right hand shown)**  
Non-Configurable or Configurable, Tablet Left or Right, 32.5" Wide



**Hakr Modular Club Chair**  
Non-Configurable or Configurable,  
32.5" Wide



**Hakr Modular Armless Lounge**  
Non-Configurable or Configurable,  
26.5" Wide



**Hakr Modular Armless Lounge, 2-Seater, 48"**  
Non-Configurable or Configurable,  
48.5" Wide



**Hakr Modular Armless Lounge, 2-Seater, 60"**  
Non-Configurable or Configurable,  
60.5" Wide



**Hakr Modular Armless Lounge, 3-Seater**  
Non-Configurable or Configurable,  
72.5" Wide



**Hakr Modular Single Arm Lounge, Left Hand**  
Non-Configurable or Configurable,  
30" Wide



**Hakr Modular Single Arm Lounge, Right Hand**  
Non-Configurable or Configurable,  
30" Wide



**Hakr Modular Corner Lounge**  
Non-Configurable or Configurable,  
30" Wide



**Hakr Modular Corner Round Lounge, 60"**  
Non-Configurable or Configurable,  
55.5" Wide



**Hakr Modular Corner Round Lounge, 90"**  
Non-Configurable or Configurable,  
52" Wide



**Hakr Modular Lounge, Connecting Table**  
14" Wide



**Hakr Modular Lounge, Square Table**  
24" Wide



**Hakr Armless Lounge w/Ledge**  
Non-Configurable or Configurable,  
26.5" Wide



**Hakr Armless Lounge w/Ledge, 2-Seater, 48"**  
Non-Configurable or Configurable,  
48.5" Wide



**Hakr Armless Lounge w/Ledge, 2-Seater, 60"**  
Non-Configurable or Configurable,  
60.5" Wide



**Hakr Armless Lounge w/Ledge, 3-Seater**  
Non-Configurable or Configurable,  
72.5" Wide



**Hakr Corner Round Lounge w/Ledge, 60"**  
Non-Configurable or Configurable,  
66" Wide



**Hakr Corner Round Lounge w/Ledge, 90"**  
Non-Configurable or Configurable,  
67" Wide



**HAKR LOUNGE**



**Hakr Privacy Lounge**  
Non-Configurable or Configurable,  
26.5" Wide



**Hakr Privacy Lounge, 2-Seater, 48"**  
Non-Configurable or Configurable,  
48.5" Wide



**Hakr Privacy Lounge, 2-Seater, 60"**  
Non-Configurable or Configurable,  
60.5" Wide



**Hakr Privacy Lounge, 3-Seater**  
Non-Configurable or Configurable,  
72.5" Wide



**Hakr Full Privacy Lounge**  
Non-Configurable or Configurable,  
28.5" Wide



**Hakr Full Privacy Lounge, 2-Seater, 48"**  
Non-Configurable or Configurable,  
50.5" Wide



**Hakr Full Privacy Lounge, 2-Seater, 60"**  
Non-Configurable or Configurable,  
62.5" Wide



**Hakr Full Privacy Lounge, 3-Seater**  
Non-Configurable or Configurable,  
74.5" Wide



**Hakr 30° Curved Bench**  
48.5" Wide



**Hakr 48° Bench**  
48.5" Wide



**Hakr 60° Bench**  
60.5" Wide



**Hakr 72° Bench**  
72.5" Wide



**Hakr Round Ottoman, 18" Mobile**  
18" Diameter



**Hakr Round Ottoman, 24" Mobile**  
24" Diameter

**NV LOUNGE**



**NV Lounge Club Chair**  
Non-Configurable or Configurable,  
34" Wide



**NV Lounge Club Chair w/Tablet (right hand shown)**  
Non-Configurable or Configurable,  
Tablet Left or Right, 34" Wide



**NV Lounge, 2-Seater**  
Non-Configurable or Configurable,  
54" Wide



**NV Lounge, 2-Seater w/Tablet (right hand shown)**  
Non-Configurable or Configurable,  
Tablet Left or Right, 54" Wide



**NV Lounge, 3-Seater**  
Non-Configurable or Configurable,  
79" Wide



**NV Lounge, 3-Seater w/Tablet (right hand shown)**  
Non-Configurable or Configurable,  
Tablet Left or Right, 79" Wide

**Portfolio**

**SOFT LOUNGE**



Soft Lounge Club Chair  
Non-Configurable or Configurable,  
40" Wide



Soft Lounge, 2-Seater  
Non-Configurable or Configurable,  
66" Wide



Soft Lounge, 3-Seater  
Non-Configurable or Configurable,  
87.5" Wide



Soft Mobile Lounge Club Chair  
Non-Configurable or Configurable,  
40" Wide



Soft Mobile Lounge, 2-Seater  
Non-Configurable or Configurable,  
66" Wide



Soft Mobile Lounge, 3-Seater  
Non-Configurable or Configurable,  
87.5" Wide



Soft Modular Lounge  
Club Chair  
Non-Configurable, 37" Wide



Soft Modular Lounge,  
2-Seater  
Non-Configurable, 66" Wide



Soft Single Arm  
Modular Lounge  
Non-Configurable, Left Hand,  
38" Wide



Soft Single Arm  
Modular Lounge  
Non-Configurable, Right Hand,  
38" Wide



Soft Modular Lounge,  
Corner  
Non-Configurable, 33" Wide



Soft Modular Lounge,  
Corner 90°  
Non-Configurable, 62" Wide



Soft Modular Lounge,  
Corner 45°  
Non-Configurable, 60.5" Wide



Soft Privacy Lounge,  
Armless  
Non-Configurable, 37.5" Wide



Soft Privacy Lounge,  
Armless, 2-Seater  
Non-Configurable, 66" Wide



Soft Full Privacy Lounge,  
Armless  
Non-Configurable, 39.5" Wide



Soft Privacy Lounge,  
Armless, 2-Seater  
Non-Configurable, 68" Wide



Soft Ottoman  
40" Wide



Soft Ottoman, 2-Seater  
85.5" Wide



Soft Ottoman, 3-Seater  
85.5" Wide



Soft Round Ottoman  
20" Diameter



Soft Round Mobile Ottoman  
20" Diameter

**PRISMA TABLES**



Prisma Large Coffee Table  
42" Diameter



Prisma Small Coffee Table  
32" Diameter



Prisma Side Table  
20" Diameter

**LB LOUNGE**



LB Lounge, 1-Seater  
2-Cushion, Configurable, Open or Solid Base  
34", 42", or 50" Heights; 30" Wide



LB Lounge, 2-Seater  
4-Cushion, Configurable, Open or Solid Base  
34", 42", or 50" Heights; 36", 42", 48", 54", or 60" Widths



LB Lounge, 3-Seater  
6-Cushion, Configurable, Open or Solid Base  
34", 42", or 50" Heights; 66" or 72" Widths

**LB LOUNGE (continued)**



**LB Lounge Backless Unit**  
Open or Solid Base (1-Cushion), Configurable  
18" Height; 30" Wide



**LB Lounge Backless Unit**  
Open or Solid Base (2-Cushion), Configurable  
18" Height; 36", 42", 48", 54", or 60" Widths



**LB Lounge, 3-Seater**  
Open or Solid Base (3-Cushion), Configurable  
18" Height; 66" or 72" Widths

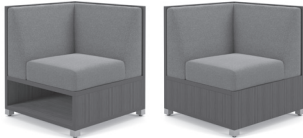

**LB Lounge Corner Unit Unit**  
Left or Right, 3-Cushion, Configurable, Open or Solid Base  
34", 42", or 50" Heights; 30" Wide



**LB Ledge**  
13" Deep (Installs to Rear of Lounge; 15" Deep (Installs to Top of Lounge  
48", 54", 60", 66", or 72" Widths



**LB Ottoman**  
Feet or Casters  
18" Height; 24", or 30" Widths

**LB LOUNGE TABLES**



**LB Lounge Corner Table**  
18" Height, 24" Width, 30" Depth



**LB Lounge Corner Table**  
18" Height, 30" Width, 30" Depth

**CHATHAM COVE**



**Chatham Cove, 2-Sided**  
Left or Right, Configurable, Powered or Non-Powered  
34", 50", or 58" Heights; 30" Wide



**Chatham Cove, 3-Sided**  
Left or Right, Configurable, Powered or Non-Powered  
34", 50", or 58" Heights; 30" Wide

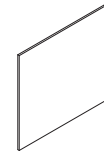

**Chatham Cove Insert**  
PET or Fabric, Powered or Non-Powered  
50" or 58" Wide; 30" Deep

**VOLKER CUBE**



**Standard Volker Cube**  
18" Height, 18" Width, 18" Depth



**Four Volker Cubes with Nesting Table**  
19 1/4" Height, 37 3/8" Width,  
37 3/8" Depth

**Product Details****AIS LOUNGE PRODUCT DETAILS**

AIS lounge products are proudly made from high-quality, sustainably-sourced materials.

Durable, long-lasting construction is achieved in every facet of each product. Hand-crafted puzzle-joinery and water-based adhesives are integrated into the structural components. High-density foam cushions ensure extended comfort. Premium materials and hardware such as powder coated paint and diecast aluminum supports accentuate the sturdiness of the product line without sacrificing in aesthetics.

Thermally-fused laminate promises durability and strength, and speaks to the extended quality of these high traffic products such as LB Lounge, Prisma tables and lounge tablet arms. High-quality fasteners and intentionally sourced hardware ensure strong connections within the product construction of laminate lounge products.

**Assembly**

Minimal assembly is required with most AIS lounge products. Instructions for LB Lounge assembly can be found on the main website, [www.ais-inc.com](http://www.ais-inc.com).

**LOUNGE COLLECTION UPHOLSTERY APPLICATION GRID**

**GRADE A UPHOLSTERY**

Name	Chatham Cove	Chic	Hakr	Juggle	LB	NV	Soft	Volker
Durdle	•	•	•	•	•	•	•	•
Medley	•	•	•	N/A	•	•	N/A	•
Mirador	•	•	•	N/A	•	•	N/A	•
Palette	•	N/A	N/A	N/A	•	N/A	N/A	•
Terrain	•	•	•	•	•	•	•	•
Wellesley	•	•	•	•	•	•	•	•

**GRADE B UPHOLSTERY**

Name	Chatham Cove	Chic	Hakr	Juggle	LB	NV	Soft	Volker
Beehave	•	•	•	•	•	•	•	•
Bobby® (Momentum)	•	•	•	N/A	•	•	N/A	•
Frock (alta)	•	•	•	•	•	•	•	•
Gem	•	•	•	•	•	•	•	•
Grid (Momentum)	•	•	•	N/A	•	•	N/A	•
Mirage (alta)	•	•	•	N/A	•	•	N/A	•
Origin (Momentum)	•	•	•	N/A	•	•	N/A	•
Rumba (Mayer)	•	•	•	•	•	•	•	•
Stamper	•	•	•	N/A	•	•	N/A	•
Sway (alta)	•	•	•	N/A	•	•	N/A	•

**GRADE C UPHOLSTERY**

Name	Chatham Cove	Chic	Hakr	Juggle	LB	NV	Soft	Volker
Fedora (Mayer)	•	•	•	•	•	•	•	•
Havana (Mayer)	•	•	•	N/A	•	•	N/A	•
Odyssey (Momentum)	•	•	•	•	•	•	•	•
Sydney (Mayer)	•	•	•	•	•	•	•	•
Tradition (Momentum)	•	•	•	•	•	•	•	•

**GRADE D UPHOLSTERY**

Name	Chatham Cove	Chic	Hakr	Juggle	LB	NV	Soft	Volker
Blazer (Camira)	•	•	•	•	•	•	•	•
Canter EPU (Momentum)	•	•	•	N/A	•	•	N/A	•
Channel (Mayer)	•	•	•	N/A	•	•	N/A	•
Charlotte (Stinson)	•	•	•	N/A	•	•	N/A	•
Cover Cloth (Momentum)	•	•	•	•	•	•	•	•
Engrave (Mayer)	•	•	•	•	•	•	•	•
Fleck (Stinson)	•	•	•	•	•	•	•	•
Haven (Mayer)	•	•	•	•	•	•	•	•
Lateral (Stinson)	•	•	•	N/A	•	•	N/A	•
Legacy (Mayer)	•	•	•	•	•	•	•	•
Point (Momentum)	•	•	•	N/A	•	•	N/A	•

**GRADE E UPHOLSTERY**

Name	Chatham Cove	Chic	Hakr	Juggle	LB	NV	Soft	Volker
Beta (Momentum)	•	N/A	N/A	N/A	•	N/A	N/A	•
Boom II (Momentum)	•	•	•	•	•	•	•	•
Faux Felt (Momentum)	•	•	•	•	•	•	•	•
Flanders (Stinson)	•	•	•	•	•	•	•	•
Hopsack (Stinson)	•	•	•	•	•	•	•	•
Outlander (Stinson)	•	•	•	•	•	•	•	•
Square One (Stinson)	•	•	•	•	•	•	•	•

**Finish Options**

**LOUNGE COLLECTION LEGS, TABLET ARMS, LEDGE AND TABLE MATERIALS APPLICATION GRID**

LEGS							
Name	Chatham Cove	Chic	Hakr	Juggle	LB	NV	Soft
Grade A Paints*	•	N/A	N/A	N/A	•	N/A	N/A
Black Paint	N/A	•	•	•	•	N/A	•
Silver Paint	N/A	•	•	•	•	•	•
Wood: Almtoo Savatre	N/A	N/A	N/A	N/A	•	N/A	Upcharge
Wood: Field Elm	N/A	N/A	N/A	N/A	•	N/A	Upcharge
Wood: Trytoo Savatre	N/A	N/A	N/A	N/A	•	N/A	Upcharge

\* Black, Chalk, Dark Tone, Grey Value 1, Innertone, Light Tone, Medium Tone, Metallic Silver, Satin White, Warm Brown

TABLET ARMS, LEDGE & TABLE LAMINATES							
Name	Chic Tables	Hakr Tablets, Tables & Ledge	LB Tables & Ledge	NV Tablet	Prisma Tables	Volker Tables	
Absolute Acajou	•	•	•	•	•	•	
Almtoo Savatre	•	•	•	•	•	•	
Black	•	•	•	•	•	•	
Brazilwood	•	•	•	•	•	•	
Chalk	•	•	•	•	•	•	
Corporate Walnut	•	•	•	•	•	•	
Dark Rum Cherry	N/A	N/A	•	N/A	N/A	•	
Field Elm	•	•	•	•	•	•	
Grand Cherry	•	•	•	•	•	•	
Grey Elm	•	•	•	•	•	•	
Landmark	•	•	•	•	•	•	
Leave Likatre	•	•	•	•	•	•	
Linen	N/A	N/A	•	N/A	N/A	•	
Looks Likatre	•	•	•	•	•	•	
Maritime Dune	N/A	N/A	•	N/A	N/A	•	
Midwest Maple	N/A	N/A	•	N/A	N/A	•	
Neo Walnut	•	•	•	•	•	•	
Phantom Ecu	•	•	•	•	•	•	
Phantom Pearl	•	•	•	•	•	•	
Storm	•	•	•	•	•	•	
Summer Drops	N/A	N/A	•	N/A	N/A	•	
True White	•	•	•	•	•	•	
Tytoo Savatre	•	•	•	•	•	•	
White Chocolate	N/A	N/A	•	N/A	N/A	•	

**Note:** All AIS alta upholstery orders will have alta application as a standard feature. Alta enables virtually any textile to withstand the rigors of real life without leaving a mark. Alta improves repellency to oil and water based stains, is easy to clean and can enhance physical properties of the fibers. The technology is permanent and imperceptible to the eye and hand. To Clean: Blot with a dry towel. If residue remains, flush with warm water. Learn more at [applied-textiles.com](http://applied-textiles.com)

**Note:**

Please check with Customer Service regarding yardage requirements when multiple chairs are ordered as there may be efficiencies when cutting materials for more than one chair. Fabrics may be discontinued or obsolete without notice. Contact AIS Customer Service with any questions regarding fabric availability. Trix requires a full yard C.O.M fabric testing.

**LOUNGE SEATING COM FABRIC REQUIREMENTS**

Series	Height	Widths	Surface	Yards per Cushion
Volker Cube	18	18	Top + Sides	2*
LB Ottoman	18	30	Top + Sides	3**
1-Seater	34	30	Back	1.25
1-Seater	34	30	Seat	1.25
2-Seater	34	36 - 60	Back	1.25
2-Seater	34	36 - 60	Seat	1.25
3-Seater	34	66 - 72	Back	1.25
3-Seater	34	66 - 72	Seat	1.25
1-Seater	42	30	Back	1.5
1-Seater	42	30	Seat	1.25
2-Seater	42	36 - 60	Back	1.5
2-Seater	42	36 - 60	Seat	1.25
3-Seater	42	66 - 72	Back	1.5
3-Seater	42	66 - 72	Seat	1.25
1-Seater	50	30	Back	1.75
1-Seater	50	30	Seat	1.25
2-Seater	50	36 - 60	Back	1.75
2-Seater	50	36 - 60	Seat	1.25
3-Seater	50	66 - 72	Back	1.75
3-Seater	50	66 - 72	Seat	1.25
Backless Unit	30	30 - 72	Seat	1.5
Corner Unit	34	30	Seat	1.25
Corner Unit	34	30	Back 1	1.25
Corner Unit	34	30	Back 2	1.25
Corner Unit	42	30	Seat	1.25
Corner Unit	42	30	Back 1	1.5
Corner Unit	42	30	Back 2	1.5
Corner Unit	50	30	Seat	1.25
Corner Unit	50	30	Back 1	1.75
Corner Unit	50	30	Back 2	1.75
Chatham Cove	34/50/58	42	Back	1.25
Chatham Cove	34/50/58	42	Seat	1.25

\*Yards per Volker Cube  
 \*\*Yards per LB Ottoman

*Lounge Seating Fabric Calculation Example:*

2-Seater (2 seats, 2 backs= 4 total cushions) requires 1.25 yards per each back cushion and 1.25 yards per each seat cushion. Total yardage needed 1.25x4 = 5 total yards.

**COM Fabric Policy**

- Please view all pre-approved COMs here: <https://www.ais-inc.com/resources/fabrics-and-finishes/pre-approved-coms>
- It is mandatory that you work directly with your AIS Customer Service Representative for all COM related testing and orders. They will provide all necessary forms to you, as well as work with you with regard to sending in correct yardage and where to send it, along with necessary RA# or #s. Please note an RA must be submitted along with the fabric for testing, as well as an RA created for an actual order.
- Customer Service must be advised as to the width of the fabric rolls being supplied (54"W or 60"W). Customer Service must also be advised if the fabric has a backer.
- Once AIS has approved the COM fabric, a fabric sample needs to be marked by the dealer with "Front", "Top", and "Bottom", to be sure fabric is applied correctly. The fabric sample then needs to be attached to a COM Fabric Dealer Form and forwarded to AIS Customer Service. The COM Fabric Dealer Form may be downloaded or printed here: [https://dealernet.ais-inc.com/media/qykjn5yl/ais-com-form\\_final\\_2024.pdf](https://dealernet.ais-inc.com/media/qykjn5yl/ais-com-form_final_2024.pdf)
- Fabrics may be discontinued or obsolete without notice.
- Contact AIS Customer Service with any questions regarding fabric availability.
- All directional fabric will be railroaded.
- Yardage requirements posted in the price list are based on non-directional 54" materials. It is important to note that 54" wide rolls need to be 54" of usable material. Please refer to the following conversion chart to determine accurate yardage requirements when COM is 54" wide and has a repeat.
- These percentages are for estimating purposes only. AIS will not be held responsible for shortages on COM products. For assistance, please contact your AIS CSR.
- Please complete this form, found on our main website, and submit to your CSR when requesting COM for testing or for an order.
- To help us expedite your test results and/or your order, please send your AIS CSR tracking information. Please clearly mark all materials with the following: dealer's name, AIS RA#, model # and quantity of items to be covered. Failure to provide your RA# will result in a delay in processing your order.
- AIS reserves the right to reject any covering that is unsuitable for upholstering our products. Approval for COM fabrics on AIS products signifies that the material in question can be applied to the products the material was specifically tested for. This approval also does not act as a form of warranty for the material's appearance, durability or behavior on AIS products.
- AIS will not be responsible for wearing, fading, stretching or poor performance of any covering materials whether supplied by the buyer or by our sources. AIS cannot be responsible for dye lot variations, defects, color inaccuracies, or any other type of flaws. While AIS does inspect fabrics for mill imperfections, not all imperfections are perceptible.
- Excess COM yardage will not be stored or returned unless clearly indicated on the purchase order.

**COM REPEAT YARDAGE CALCULATION**

Repeat	Across Roll	Up the Roll	2-Way Repeat
1-5"	Add 10%	Add 15%	Add 15%
6-9"	Add 15%	Add 20%	Add 25%
10-13"	Add 20%	Add 25%	Add 30%
14-20"	Add 25%	Add 30%	Add 35%
21-27"	Add 30%	Add 35%	Add 40%
28-34"	Add 35%	Add 40%	Add 45%

**COM Yardage Requirements for Non-Configurable Models**

<b>AIS LOUNGE COM YARDAGE REQUIREMENTS – NON-CONFIGURABLE</b>				
<b>DESCRIPTION</b>		<b>YARDAGE</b>		
<b>Juggle</b>		<b>Nonconfigurable</b>	<b>Seat</b>	<b>Screen</b>
LJ1	Juggle Chair, Cross Wire Base*	2.25	-	-
LJ2	Juggle chair, 4-leg swivel base, auto return*	2.25	-	-
LJ3	Juggle chair, 5-star swivel base on casters*	2.25	-	-
<b>Chic</b>				
LCHC1	Chic club chair, metal legs	5	-	-
LCHC2	Chic 2-Seater, metal legs	6	-	-
LCHC3	Chic 3-Seater, metal legs	7	-	-
LCHC1C	Chic club chair, metal legs, Configurable	5	-	-
LCHC2C	Chic 2-Seater, metal legs, Configurable	6	-	-
LCHC3C	Chic 3-Seater, metal legs, Configurable	7	-	-
<b>Hakr Mobile Lounge</b>				
LHKRM	Hakr mobile lounge	4.75	-	-
LHKRMTR	Hakr mobile lounge, tablet RH	4.75	-	-
LHKRMTL	Hakr mobile lounge, tablet LH	4.75	-	-
LHKRMC	Hakr mobile lounge, Configurable	4.75	-	-
LHKRMTRC	Hakr mobile lounge, tablet RH, Configurable	4.75	-	-
LHKRMTLC	Hakr mobile lounge, tablet LH, Configurable	4.75	-	-
<b>Hakr Modular Lounge</b>				
LHKR	Hakr Lounge Club Chair	4.75	-	-
LHKRMODNA	Hakr Modular Lounge, armless	3	-	-
LHKRMOD2NA50	Hakr Modular Lounge, 2-Seater, armless, 50"W	4.5	-	-
LHKRMOD2NA60	Hakr Modular Lounge, 2-Seater, armless, 60"W	6	-	-
LHKRMOD3NA	Hakr Modular Lounge, 3-Seater, armless	7	-	-
LHKRMODRH	Hakr Modular Lounge, Single Arm RH	4.25	-	-
LHKRMODLH	Hakr Modular Lounge, Single Arm, LH	4.25	-	-
LHKRMODCRNR	Hakr Modular Lounge, Corner, Square	5	-	-
LHKRMODCRNR60	Hakr Corner, Round, 60-degree	5.5	-	-
LHKRMODCRNR90	Hakr Corner, Round, 90-degree	5	-	-
LHKRC	Hakr Lounge Club Chair, Configurable	4.75	-	-
LHKRMODNAC	Hakr Modular Lounge, armless, Configurable	3	-	-
LHKRMOD2NA50C	Hakr Modular Lounge, 2-Seater, Armless, 50W, Configurable	4.5	-	-
LHKRMOD2NA60C	Hakr Modular Lounge, 2-Seater, Armless, 60W, Configurable	6	-	-
LHKRMOD3NAC	Hakr Modular Lounge, 3-Seater, Armless, Configurable	7	-	-
LHKRMODRHC	Hakr Modular Lounge, Single Arm RH, Configurable	4.25	-	-
LHKRMODLHC	Hakr Modular Lounge, Single Arm, LH, Configurable	4.25	-	-
LHKRMODCRNRC	Hakr Modular Lounge, Corner, Square, Configurable	5	-	-
LHKRMODCRNR60C	Hakr Corner, Round, 60-degree, Configurable	5.5	-	-
LHKRMODCRNR90C	Hakr Corner, Round, 90-degree, Configurable	5	-	-

\* Minimum quantity of 10 Juggle chairs required when using COM fabric.



**COM Yardage Requirements for Non-Configurable Models**

**AI5 LOUNGE COM YARDAGE REQUIREMENTS – NON-CONFIGURABLE**

DESCRIPTION		YARDAGE		
		Nonconfigurable	Seat	Screen
<b>Hakr Lounge with Ledge</b>				
LHKRLL	Hakr Lounge w/ ledge	3	-	-
LHKRLL248	Hakr Lounge w/ Ledge 2-seater, 48"W	4.75	-	-
LHKRLL260	Hakr Lounge w/ Ledge 2-seater, 60"W	5.75	-	-
LHKRLL3	Hakr Lounge w/ Ledge 3-Seater	7	-	-
LHKRLLCRNR60	Hakr Lounge w/ Ledge, Round Corner, 60-degree	5.5	-	-
LHKRLLCRNR90	Hakr Lounge w/ Ledge, Round Corner, 90-degree	5	-	-
LHKRLLC	Hakr Lounge w/ ledge, Configurable	3	-	-
LHKRLL248C	Hakr Lounge w/ Ledge 2-seater, 48"W, Configurable	4.75	-	-
LHKRLL260C	Hakr Lounge w/ Ledge 2-seater, 60"W, Configurable	5.75	-	-
LHKRLL3C	Hakr Lounge w/ Ledge 3-Seater, Configurable	7	-	-
LHKRLLCRNR60C	Hakr Lounge w/ Ledge, Round Corner, 60-degree, Configurable	5.5	-	-
LHKRLLCRNR90C	Hakr Lounge w/ Ledge, Round Corner, 90-degree, Configurable	5	-	-
<b>Hakr Privacy Lounge</b>				
LHKRPL	Hakr Screen Lounge	-	3	2
LHKRPL248	Hakr Screen Lounge, 2-Seater, 48"W	-	4.75	3
LHKRPL260	Hakr Screen Lounge, 2-Seater, 60"W	-	9.75	3.75
LHKRPL3	Hakr Screen Lounge, 3-Seater	-	11.5	4.5
LHKRPLC	Hakr Screen Lounge, Configurable	-	3	2
LHKRPL248C	Hakr Screen Lounge, 2-Seater, 48"W, Configurable	-	4.75	3
LHKRPL260C	Hakr Screen Lounge, 2-Seater, 60"W, Configurable	-	9.75	3.75
LHKRPL3C	Hakr Screen Lounge, 3-Seater, Configurable	-	11.5	4.5
<b>Hakr Full Privacy Lounge</b>				
LHKRFPL	Hakr Full Screen Lounge	-	3	4
LHKRFPL248	Hakr Full Screen Lounge, 2-Seater, 48"W	-	4.75	7
LHKRFPL260	Hakr Full Screen Lounge, 2-seater, 60"W	-	6	7.75
LHKRFPL3	Hakr Full Screen Lounge, 3-Seater	-	7	8.5
LHKRFPLC	Hakr Full Privacy Lounge, Configurable	-	3	4
LHKRFPL248C	Hakr Full Privacy Lounge, 2-Seater, 48"W, Configurable	-	4.75	7
LHKRFPL260C	Hakr Full Privacy Lounge, 2-seater, 60"W, Configurable	-	6	7.75
LHKRFPL3C	Hakr Full Privacy Lounge, 3-Seater, Configurable	-	7	8.5
<b>Hakr Benches &amp; Ottomans</b>				
LHK18	Hakr Round Ottoman, 18 dia, Mobile	1.5	-	-
LHK24	Hakr Round Ottoman, 24 dia, Mobile	2	-	-
LHKB30	Hakr Bench, 30-degree	2.75	-	-
LHKB48	Hakr Bench, 48"	3.5	-	-
LHKB60	Hakr Bench, 60"	4	-	-
LHKB72	Hakr Bench, 72"	4.75	-	-

**COM Yardage Requirements for Non-Configurable Models**

<b>AIS LOUNGE COM YARDAGE REQUIREMENTS – NON-CONFIGURABLE</b>				
<b>DESCRIPTION</b>		<b>YARDAGE</b>		
<b>NV Lounge</b>		<b>Nonconfigurable</b>	<b>Seat</b>	<b>Screen</b>
LNV1	NV Club Chair, metal legs	4.75	-	-
LNV1TR	NV Club Chair, metal legs, tablet RH	4.75	-	-
LNV1TL	NV Club Chair, metal legs, tablet LH	4.75	-	-
LNV2	NV 2-Seater, metal legs	6.75	-	-
LNV2TR	NV 2-Seater, metal legs, tablet RH	6.75	-	-
LNV2TL	NV 2-Seater, metal legs, tablet LH	6.75	-	-
LNV3	NV 3-Seater, metal legs	8.25	-	-
LNV3TR	NV 3-Seater, metal legs, tablet RH	8.25	-	-
LNV3TL	NV 3-Seater, metal legs, tablet LH	8.25	-	-
LNV1C	NV Club Chair, metal legs, configurable	4.75	-	-
LNV1TRC	NV Club Chair, metal legs, tablet RH, configurable	4.75	-	-
LNV1TLC	NV Club Chair, metal legs, tablet LH, configurable	4.75	-	-
LNV2C	NV 2-Seater, metal legs, Configurable	6.75	-	-
LNV2TRC	NV 2-Seater, metal legs, tablet RH, Configurable	6.75	-	-
LNV2TLC	NV 2-Seater, metal legs, tablet LH, Configurable	6.75	-	-
LNV3C	NV 3-Seater, metal legs, Configurable	8.25	-	-
LNV3TRC	NV 3-Seater, metal legs, tablet RH, Configurable	8.25	-	-
LNV3TLC	NV 3-Seater, metal legs, tablet LH, Configurable	8.25	-	-
<b>Soft Lounge</b>				
LSOFT1	Soft Lounge Club Chair	5	-	-
LSOFT2	Soft Lounge 2-Seater	7.5	-	-
LSOFT3	Soft Lounge 3-Seater	8.75	-	-
LSOFT1C	Soft Lounge Club Chair, Configurable	5	-	-
LSOFT2C	Soft Lounge 2-Seater, Configurable	7.5	-	-
LSOFT3C	Soft Lounge 3-Seater, Configurable	8.75	-	-
<b>Soft Mobile Lounge</b>				
LSOFT1M	Soft Lounge Mobile Club Chair	5	-	-
LSOFT2M	Soft Lounge Mobile 2-Seater	7.5	-	-
LSOFT3M	Soft Lounge Mobile 3-Seater	8.75	-	-
LSOFT1MC	Soft Lounge Mobile Club Chair, Configurable	5	-	-
LSOFT2MC	Soft Lounge Mobile 2-Seater, Configurable	7.5	-	-
LSOFT3MC	Soft Lounge Mobile 3-Seater, Configurable	8.75	-	-
<b>Soft Modular Lounge</b>				
LSOFTMOD	Soft Modular Lounge	4.5	-	-
LSOFTMOD2	Soft Modular Lounge, 2-seat	6.25	-	-
LSOFTMODRH	Soft Modular Lounge, Single Arm RH	4.5	-	-
LSOFTMODLH	Soft Modular Lounge, Single Arm LH	4.5	-	-
LSOFTCRNR	Soft Modular Lounge Corner	4.5	-	-
LSOFTCRNR90	Soft Modular Lounge Corner, 90-degree	8.25	-	-
LSOFTCRNR45	Soft Modular Lounge Corner, 45-degree	8.25	-	-

**COM Yardage Requirements for Non-Configurable Models**

<b>AIS LOUNGE COM YARDAGE REQUIREMENTS – NON-CONFIGURABLE</b>				
<b>DESCRIPTION</b>		<b>YARDAGE</b>		
		<b>Nonconfigurable</b>	<b>Seat</b>	<b>Screen</b>
<b>Soft Privacy Lounge</b>				
LSOFTPL	Soft Privacy lounge, armless	-	4.5	2.5
LSOFTPL2	Soft Privacy Lounge, Armless, 2-Seater	-	6.25	4
<b>Soft Full Privacy Lounge</b>				
LSOFTFPL	Soft Full Privacy Lounge	-	4.5	6.5
LSOFTFPL2	Soft Full Privacy Lounge, 2-Seater	-	6.25	8.5
<b>Soft Benches &amp; Ottomans</b>				
LSOFT-B1	Soft Lounge Ottoman	4	-	-
LSOFT-B2	Soft Lounge 2-Seater Ottoman	5.75	-	-
LSOFT-B3	Soft Lounge 3-Seater Ottoman	7	-	-
LSOFT-R16	Soft Round Ottoman, 16"H	1.25	-	-
LSOFT-R18	Soft Round Mobile Ottoman, 18"H	1.25	-	-

**COM Yardage Requirements for Configurable Models**

<b>AIS LOUNGE COM YARDAGE REQUIREMENTS – CONFIGURABLE</b>					
<b>DESCRIPTION</b>			<b>YARDAGE</b>		
<b>Chic</b>			<b>Seat</b>	<b>Main</b>	<b>Screen</b>
LCHC1C	Chic club chair, metal legs, Configurable		1.50	3.75	-
LCHC2C	Chic 2-Seater, metal legs, Configurable		2.00	5.00	-
LCHC3C	Chic 3-Seater, metal legs, Configurable		2.25	5.25	-
<b>Hakr Mobile Lounge</b>					
LHKRC	Hakr Lounge Club Chair, Configurable		1.75	4.50	-
LHKRMODNAC	Hakr Modular Lounge, armless, Configurable		2.00	2.50	-
LHKRMOD2NA50C	Hakr Modular Lounge, 2-Seater, Armless, 50W, Configurable		2.50	3.75	-
LHKRMOD2NA60C	Hakr Modular Lounge, 2-Seater, Armless, 60W, Configurable		3.00	4.50	-
LHKRMOD3NAC	Hakr Modular Lounge, 3-Seater, Armless, Configurable		3.25	5.25	-
LHKRMODRHC	Hakr Modular Lounge, Single Arm RH, Configurable		2.00	3.75	-
LHKRMODLHC	Hakr Modular Lounge, Single Arm, LH, Configurable		2.00	3.75	-
LHKRMODCRNRC	Hakr Modular Lounge, Corner, Square, Configurable		1.75	4.75	-
LHKRMODCRNR60C	Hakr Corner, Round, 60-degree, Configurable		3.00	4.25	-
LHKRMODCRNR90C	Hakr Corner, Round, 90-degree, Configurable		2.75	4.25	-
<b>Hakr Lounge with Ledge</b>					
LHKRLLC	Hakr Lounge w/ ledge, Configurable		2.00	2.50	-
LHKRLL248C	Hakr Lounge w/ Ledge 2-seater, 48"W, Configurable		2.50	3.75	-
LHKRLL260C	Hakr Lounge w/ Ledge 2-seater, 60"W, Configurable		3.00	4.50	-
LHKRLL3C	Hakr Lounge w/ Ledge 3-Seater, Configurable		3.25	5.25	-
LHKRLLCRNR60C	Hakr Lounge w/ Ledge, Round Corner, 60-degree, Configurable		3.00	4.25	-
LHKRLLCRNR90C	Hakr Lounge w/ Ledge, Round Corner, 90-degree, Configurable		2.75	4.25	-
<b>Hakr Privacy Lounge</b>					
LHKRPLC	Hakr Screen Lounge, Configurable		2.00	2.50	2.25
LHKRPL248C	Hakr Screen Lounge, 2-Seater, 48"W, Configurable		2.50	3.75	3.50
LHKRPL260C	Hakr Screen Lounge, 2-Seater, 60"W, Configurable		3.00	4.50	4.00
LHKRPL3C	Hakr Screen Lounge, 3-Seater, Configurable		3.25	5.00	4.50
<b>Hakr Full Privacy Lounge</b>					
LHKRFPLC	Hakr Full Privacy Lounge, Configurable		2.00	2.50	4.00
LHKRFPL248C	Hakr Full Privacy Lounge, 2-Seater, 48"W, Configurable		2.50	3.75	7.00
LHKRFPL260C	Hakr Full Privacy Lounge, 2-seater, 60"W, Configurable		3.00	4.50	7.75
LHKRFPL3C	Hakr Full Privacy Lounge, 3-Seater, Configurable		3.25	5.25	8.50
<b>NV Lounge</b>					
LNV1C	NV Club Chair, metal legs, configurable		1.25	4.50	-
LNV1TRC	NV Club Chair, metal legs, tablet RH, configurable		1.25	4.50	-
LNV1TLC	NV Club Chair, metal legs, tablet LH, configurable		1.25	4.50	-
LNV2C	NV 2-Seater, metal legs, Configurable		2.00	5.50	-
LNV2TRC	NV 2-Seater, metal legs, tablet RH, Configurable		2.00	5.50	-
LNV2TLC	NV 2-Seater, metal legs, tablet LH, Configurable		2.00	5.50	-
LNV3C	NV 3-Seater, metal legs, Configurable		2.75	6.50	-
LNV3TRC	NV 3-Seater, metal legs, tablet RH, Configurable		2.75	6.50	-
LNV3TLC	NV 3-Seater, metal legs, tablet LH, Configurable		2.75	6.50	-

**COM Yardage Requirements for Configurable Models**

<b>AIS LOUNGE COM YARDAGE REQUIREMENTS – CONFIGURABLE</b>				
<b>DESCRIPTION</b>		<b>YARDAGE</b>		
		<b>Seat</b>	<b>Main</b>	<b>Screen</b>
<b>Soft Lounge</b>				
LSOFT1C	Soft Lounge Club Chair, Configurable	1.50	4.75	-
LSOFT2C	Soft Lounge 2-Seater, Configurable	2.25	6.00	-
LSOFT3C	Soft Lounge 3-Seater, Configurable	2.75	7.25	-
<b>Soft Mobile Lounge</b>				
LSOFT1MC	Soft Lounge Mobile Club Chair, Configurable	1.50	4.75	-
LSOFT2MC	Soft Lounge Mobile 2-Seater, Configurable	2.25	6.00	-
LSOFT3MC	Soft Lounge Mobile 3-Seater, Configurable	2.75	7.25	-

**Laminate Woodgrain Direction**

**HAKR LOUNGE**



Hakr Connecting Table



Hakr Square Table

**CHATHAM COVE LOUNGE**



Chatham Cove 34"H,  
3-Sided Right



Chatham Cove 58"H,  
2-Sided Left

**CHIC LOUNGE**



Chic Side Table

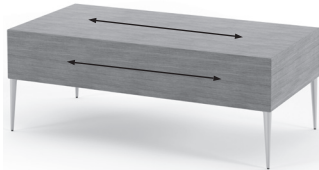

Chic 2-Seater Table

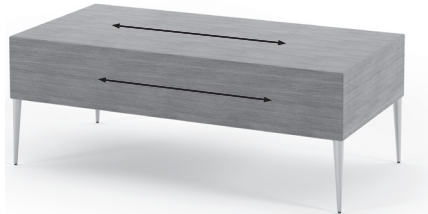

Chic 3-Seater Table

**LB LOUNGE**



LB Lounge Solid Base 3-Seater

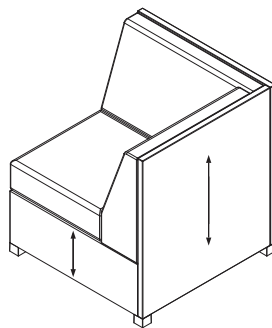

LB Lounge Right Corner  
Solid Base

**LOUNGE**

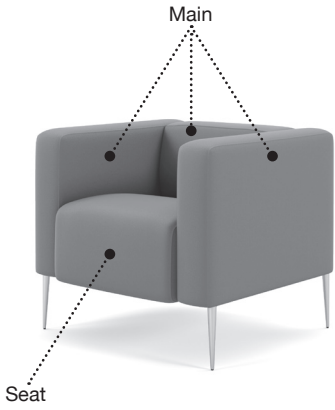

**LCHC1C**  
Club Chair

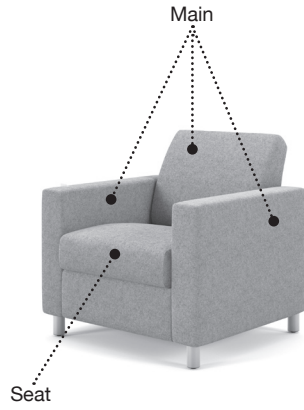

**LNV1**  
Club Chair

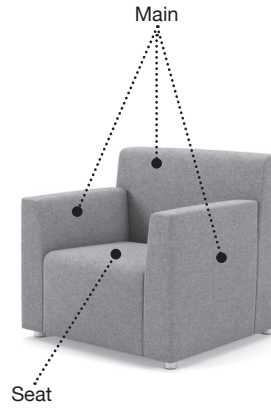

**LHKR**  
Club Chair

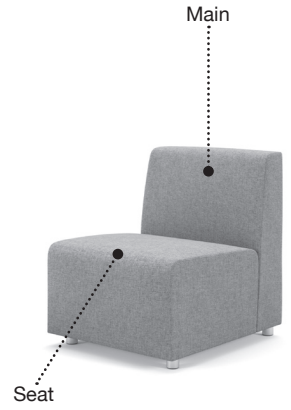

**LHKRMODNA**  
Armless Lounge

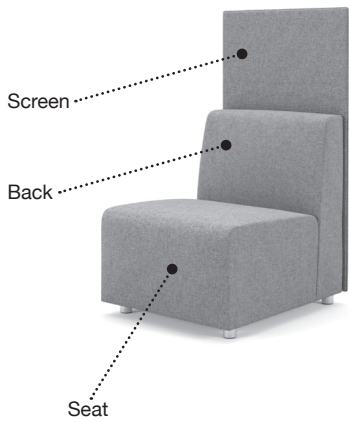

**LHKRPL**  
Privacy Lounge

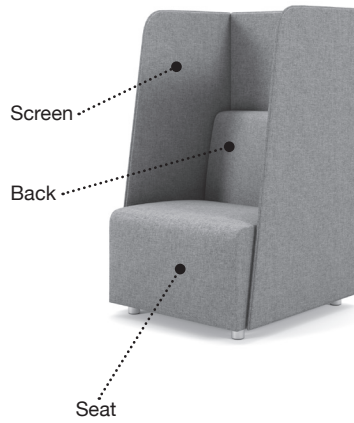

**LHKRFPL**  
Full Privacy Lounge

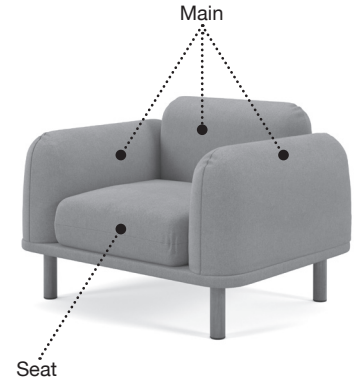

**LSOFT1**  
Club Chair

**Chic Lounge**

**CHIC LOUNGE PRODUCT INFORMATION**

The Chic lounge collection features a classic silhouette and reserved design that elevates the look and feel of any space. Generous cushions offer exceptional comfort while the sleek profile of the metal legs offer a modern, bold statement. Bring refinement into any environment with the introduction of Chic.



**Chic Club Chair**



**Chic 2-Seater**



**Chic 3-Seater**

**FEATURES AND BENEFITS**

- High-density, fixed foam cushions for extended support and comfort.
- Puzzle joinery frame in sustainably sourced hardwood ensures strength and longevity.
- Diecast aluminum legs measuring 8.5”H available in silver and black.
- Ships fully assembled.

**SPECIFY**

- Upholstery selection
- Configurable models include fabric selection for seat and separate fabric selection for the main
- Leg paint color selection: black or silver

**PRODUCT SPECIFICATIONS**

<b>Model</b>	<b>Weight (lbs)</b>	<b>Width (Inches)</b>	<b>Depth (Inches)</b>	<b>Height (Inches)</b>	<b>Seat Height (Inches)</b>	<b>Seat Width (Inches)</b>	<b>Seat Depth (Inches)</b>	<b>Arm Height (floor to top of arm, in inches)</b>	<b>Arm Height (top of seat to top of arm, in inches)</b>
Chic Club	65	33	30.5	29	19	21.5	21	28.25	9.75
Chic 2-Seater	90	53	30.5	29	19	42	21	28.25	9.75
Chic 3-Seater	110	73	30.5	29	19	61.5	21	28.25	9.75



**CHIC LOUNGE MODELS AND OPTIONS**



**LCHC1C**  
Club Chair  
W 33" | D 30.5" | H 29"  
SW 21.5" | SD 21" | SH 19"



**LCHC2C**  
2-Seater  
W 53" | D 30.5" | H 29"  
SW 41" | SD 21" | SH 19"



**LCHC3C**  
3-Seater  
W 73" | D 30.5" | H 29"  
SW 61.5" | SD 21" | SH 19"

**NON-CONFIGURABLE CHIC LOUNGE**

Model Number	Description	Grade A Upholstery / COM	Grade B Upholstery	Grade C Upholstery	Grade D Upholstery	Grade E Upholstery
LCHC1	Chic club chair, metal legs	1,830	+68	+99	+130	+157
LCHC2	Chic 2-Seater, metal legs	2,400	+82	+119	+155	+189
LCHC3	Chic 3-Seater, metal legs	2,995	+95	+139	+181	+220

**CONFIGURABLE CHIC LOUNGE**

Model Number	Description	Grade A Upholstery / COM	Grade B Upholstery		Grade C Upholstery		Grade D Upholstery		Grade E Upholstery	
			Seat	Main	Seat	Main	Seat	Main	Seat	Main
LCHC1C	Chic club chair, metal legs, Configurable	1,885	+20	+48	+30	+69	+39	+91	+47	+110
LCHC2C	Chic 2-Seater, metal legs, Configurable	2,455	+24	+57	+36	+83	+47	+109	+57	+132
LCHC3C	Chic 3-Seater, metal legs, Configurable	3,050	+29	+67	+42	+97	+54	+127	+66	+154

**Chic Tables**

**CHIC TABLES PRODUCT INFORMATION**

The Chic table collection pairs perfectly with the Chic lounge design, sharing the same sleek metal leg profile and available in a wide variety of warm woodgrains to soften any space. Three different sizes complement the footprint of the lounge while offering adequate space to comfortably work or relax with ease.



**Chic Side Table**



**Chic 2-Seater Table**



**Chic 3-Seater Table**

**FEATURES AND BENEFITS**

- Sustainably sourced hardwood frame.
- Diecast aluminum 8.5”H legs available in silver and black.
- Tables are available in a variety of Grade A laminates.
- See Lounge Finish Options for more information.

**SPECIFY**

- Laminate selection
- Leg paint color selection: black or silver

**PRODUCT SPECIFICATIONS**

<b>Model</b>	<b>Weight (lbs)</b>	<b>Height (Inches)</b>	<b>Width (Inches)</b>	<b>Depth (Inches)</b>
Chic Side Table	25	20	21	13
Chic 2-Seater Table	40	16	42	21
Chic 3-Seater Table	60	16	62	21

**CHIC TABLES MODELS AND OPTIONS**



**TL-CHCTB**  
Side Table  
W 21" | D 13" | H 20"



**TL-CHCTB2**  
2-Seater Table  
W 42" | D 21" | H 16"

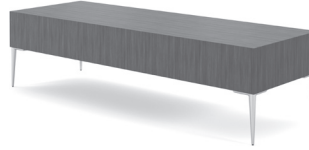

**TL-CHCTB3**  
3-Seater Table  
W 62" | D 21" | H 16"

**CHIC LOUNGE TABLES**

<b>Model Number</b>	<b>Description</b>	<b>List Price</b>
TL-CHCTB	Chic Side table	1,630
TL-CHCTB2	Chic 2-Seater table	2,200
TL-CHCTB3	Chic 3-Seater table	2,515

**Juggle Seating**

**JUGGLE SEATING PRODUCT INFORMATION**

The Juggle line is a welcoming and highly versatile seating solution, featuring a fully-upholstered, contoured one-piece seat that supports a variety of working positions. From the conference room to the private office, Juggle is high multi-functional with three base options: cross wire, four-leg auto return swivel, and a five-star swivel on casters. Subtle, quality-inspired details such as a single tuft line across the back and fully-upholstered arms promise maximum comfort to support any task.



**Juggle 5-Star Base**



**Juggle Cross Wire Base**



**Juggle 4-Leg Swivel Base, with auto return**

**FEATURES AND BENEFITS**

- Body contouring fully-upholstered seat with high-density foam for extended comfort.
- 300 pound rating.
- CAL117 compliant.
- Ships fully assembled.
- 50mm non-locking casters with durometer of 85HA.
- Puzzle joinery frame in sustainably sourced hardwood ensures strength and longevity.
- Three base options available in black or silver.
- Minimum order quantity of 10 required if using COM fabric.

**SPECIFY**

- Upholstery selection
- Leg/base paint color selection: black or silver

**PRODUCT SPECIFICATIONS**

<b>Model</b>	<b>Weight (lbs)</b>	<b>Width (Inches)</b>	<b>Depth (Inches)</b>	<b>Height (Inches)</b>	<b>Seat Height (Inches)</b>	<b>Seat Width (Inches)</b>	<b>Seat Depth (Inches)</b>	<b>Arm Height (floor to top of arm, in inches)</b>	<b>Arm Height (top of seat to top of arm, in inches)</b>
Juggle Seating	27	23	26	32	18.5	19	17.5	25	7.25

**JUGGLE SEATING MODELS AND OPTIONS**



**LJ1**  
Cross Wire Base  
W 23" | D 26" | H 32"  
SW 19" | SD 17.5" | SH 18.5"



**LJ2**  
4-Leg Swivel Base  
W 23" | D 26" | H 32"  
SW 19" | SD 17.5" | SH 18.5"



**LJ3**  
5-Star Swivel Base on Casters  
W 23" | D 26" | H 32"  
SW 19" | SD 17.5" | SH 18.5"

**JUGGLE CHAIRS**

<b>Model Number</b>	<b>Description</b>	<b>Grade A Upholstery / COM</b>	<b>Grade B / alta Upholstery</b>	<b>Grade C Upholstery</b>	<b>Grade D Upholstery</b>	<b>Grade E Upholstery</b>
LJ1	Juggle Chair, cross wire base	1,220	+31	+45	+58	+71
LJ2	Juggle Chair, 4-leg swivel base, auto return	1,255	+31	+45	+58	+71
LJ3	Juggle Chair, 5-star swivel base on casters	1,340	+31	+45	+58	+71

**Hakr Mobile Lounge**

**HAKR MOBILE LOUNGE PRODUCT INFORMATION**

Hakr’s straightforward design with clean lines and sculpted profile offers lasting comfort. Unobtrusive casters allow you to move where your work takes you, and the tablet arm feature promotes productivity without sacrificing aesthetics. From the café to collaborative spaces, Hakr brings comfort to work.



**Hakr Mobile Lounge**



**Hakr Mobile Lounge with Tablet Arm**  
(right hand tablet shown)

**FEATURES AND BENEFITS**

- High-density, fixed foam cushions for extended support and comfort.
- Puzzle joinery frame in sustainably sourced hardwood ensures strength and longevity.
- Tablet arm measures 10”W at the widest part and 16”L, and sits 2.44” above the chair arm.
- 300 pound rating.
- CAL117 compliant.
- Ships fully assembled. Optional tablet arms ship separately.
- 50mm casters; front 2 casters are non-locking, rear 2 casters are locking.
- Optional tablet arm.

**SPECIFY**

- Upholstery selection (configurable models include fabric selection for seat and separate fabric selection for surround)
- Laminate selection (tablet models only)

**PRODUCT SPECIFICATIONS**

<b>Model</b>	<b>Weight (lbs)</b>	<b>Height (Inches)</b>	<b>Width (Inches)</b>	<b>Depth (Inches)</b>	<b>Seat Height (Inches)</b>	<b>Seat Width (Inches)</b>	<b>Seat Depth (Inches)</b>	<b>Arm Height (floor to top of arm, in inches)</b>	<b>Arm Height (top of seat to top of arm, in inches)</b>
Hakr Mobile Lounge	65	31	32.5	30	17	21	21	24	7.5
Hakr Mobile Lounge, Right Arm Tablet	65	31	32.5	30	17	21	21	24	7.5
Hakr Mobile Lounge, Left Arm Tablet	65	31	32.5	30	17	21	21	24	7.5

**HAKR MOBILE LOUNGE MODELS AND OPTIONS**



**LHKRM**  
Mobile Lounge  
W 32.5" | D 30" | H 31"  
SW 21" | SD 21" | SH 17"



**LHKRMTR**  
Mobile Lounge, Right Tablet  
W 32.5" | D 30" | H 31"  
SW 21" | SD 21" | SH 17"



**LHKRMTL**  
Mobile Lounge, Left Tablet  
W 32.5" | D 30" | H 31"  
SW 21" | SD 21" | SH 17"

**NON-CONFIGURABLE HAKR MOBILE LOUNGE**

Model Number	Description	Grade A Upholstery / COM	Grade B / alta Upholstery	Grade C Upholstery	Grade D Upholstery	Grade E Upholstery
LHKRM	Hakr Mobile Lounge	1,550	+65	+94	+123	+149
LHKRMTR	Hakr Mobile Lounge, Tablet RH	2,180	+65	+94	+123	+149
LHKRMTL	Hakr Mobile Lounge, Tablet LH	2,180	+65	+94	+123	+149

**CONFIGURABLE HAKR MOBILE LOUNGE**

Model Number	Description	Grade A Upholstery / COM	Grade B / alta Upholstery		Grade C Upholstery		Grade D Upholstery		Grade E Upholstery	
			Seat	Main	Seat	Main	Seat	Main	Seat	Main
LHKRMC	Hakr Mobile Lounge, Configurable	1,605	+19	+45	+28	+66	+37	+86	+45	+105
LHKRMTRC	Hakr Mobile Lounge, Tablet RH, Configurable	2,235	+19	+45	+28	+66	+37	+86	+45	+105
LHKRMTLC	Hakr Mobile Lounge, Tablet LH, Configurable	2,235	+19	+45	+28	+66	+37	+86	+45	+105

**Hakr Modular Lounge**

**HAKR MODULAR LOUNGE PRODUCT INFORMATION**

The Hakr Modular Lounge line shares the same clean lines and straightforward design as the Hakr Mobile Lounge, ensuring lasting comfort. Featuring a combination of shapes and sizes, including rounded corners in 60- and 90-degree curves, Hakr Modular Lounge create linear or organic configurations to promote collaboration and connection. Lounge, meet Hakr.



**Hakr Modular Lounge**

**FEATURES AND BENEFITS**

- High-density, fixed foam cushions for extended support and comfort.
- Puzzle joinery frame in sustainably sourced hardwood ensures strength and longevity.
- Steel feet provide durability.
- 300 pound rating.
- CAL117 compliant.
- Ships fully assembled.
- Ganging clips included.

**SPECIFY**

- Upholstery selection
- Configurable models include fabric selection for seat and separate fabric selection for the main
- Leg paint color selection: black or silver

**PRODUCT SPECIFICATIONS**

<b>Model</b>	<b>Weight (lbs)</b>	<b>Height (Inches)</b>	<b>Width (Inches)</b>	<b>Depth (Inches)</b>	<b>Seat Height (Inches)</b>	<b>Seat Width (Inches)</b>	<b>Seat Depth (Inches)</b>	<b>Arm Height (floor to top of arm, in inches)</b>	<b>Arm Height (top of seat to top of arm, in inches)</b>
Hakr Lounge Club Chair	65	31	32.5	30	17	21	21	24	7.5
Hakr Modular Lounge, Armless	45	31	26.5	30	17	26.5	21	N/A	N/A
Hakr Modular Lounge, 2-Seater, Armless, 50"W	55	31	48.5	30	17	48.5	21	N/A	N/A
Hakr Modular Lounge, 2-Seater, Armless, 60"W	65	31	60.5	30	17	60.5	21	N/A	N/A
Hakr Modular Lounge, 3-Seater, Armless	75	31	72.5	30	17	72.5	21	N/A	N/A
Hakr Modular Lounge, Single Arm, Right Hand	55	31	30	30	17	24	21	24	7.5
Hakr Modular Lounge, Single Arm, Left Hand	55	31	30	30	17	24	21	24	7.5
Hakr Modular Lounge, Corner, Square	55	31	30	30	17	21	21	24	7.5
Hakr Corner, Round, 60 degree	80	31	55.5	33.5	17	46.5	21	N/A	N/A
Hakr Corner, Round, 90 degree	65	31	52	32	17	40	21	N/A	N/A



**HAKR MODULAR LOUNGE MODELS AND OPTIONS**



**LHKR**  
Club Chair  
W 32.5" | D 30" | H 31"  
SW 21" | SD 21" | SH 17"



**LHKRMODNA**  
Armless Lounge  
W 26.5" | D 30" | H 31"  
SW 26.5" | SD 21" | SH 17"



**LHKRMOD2NA50**  
Modular Lounge, 2-Seater (50")  
W 48.5" | D 30" | H 31"  
SW 48.5" | SD 21" | SH 17"



**LHKRMOD2NA60**  
Modular Lounge, 2-Seater (60")  
W 60.5" | D 30" | H 31"  
SW 60.5" | SD 21" | SH 17"



**LHKRMOD3NA**  
Modular Lounge, 3-Seater  
W 72.5" | D 30" | H 31"  
SW 72.5" | SD 21" | SH 17"



**LHKRMODLH**  
Single Arm Lounge, Left Hand  
W 30" | D 30" | H 31"  
SW 24" | SD 21" | SH 17"



**LHKRMODRH**  
Single Arm Lounge, Right Hand  
W 30" | D 30" | H 31"  
SW 24" | SD 21" | SH 17"



**LHKRMODCRNR**  
Corner Lounge  
W 30" | D 30" | H 31"  
SW 21" | SD 21" | SH 17"



**LHKRMODCRNR60**  
Corner Round 60"  
W 55.5" | D 33.5" | H 31"  
SW 46.5" | SD 21" | SH 17"



**LHKRMODCRNR90**  
Corner Round 90"  
W 52" | D 32" | H 31"  
SW 40" | SD 21" | SH 17"

**NON-CONFIGURABLE HAKR MODULAR LOUNGE**

Model Number	Description	Grade A Upholstery / COM	Grade B / alta Upholstery	Grade C Upholstery	Grade D Upholstery	Grade E Upholstery
LHKR	Hakr Lounge Club Chair	1,630	+65	+94	+123	+149
LHKRMODNA	Hakr Modular Lounge, Armless	1,250	+41	+60	+78	+94
LHKRMOD2NA50	Hakr Modular Lounge, 2-Seater, Armless, 50"W	1,900	+65	+94	+123	+149
LHKRMOD2NA60	Hakr Modular Lounge, 2-Seater, Armless, 60"W	2,250	+82	+119	+155	+189
LHKRMOD3NA	Hakr Modular Lounge, 3-Seater, Armless	2,475	+95	+139	+181	+220
LHKRMODRH	Hakr Modular Lounge, Single Arm, RH	1,563	+58	+84	+110	+134
LHKRMODLH	Hakr Modular Lounge, Single Arm, LH	1,563	+58	+84	+110	+134
LHKRMODCRNR	Hakr Modular Lounge, Corner, Square	1,751	+68	+99	+130	+157
LHKRMODCRNR60	Hakr Corner, Round, 60 degree	2,300	+75	+109	+143	+173
LHKRMODCRNR90	Hakr Corner, Round, 90 degree	2,150	+68	+99	+130	+157

**Hakr Modular Lounge**

**CONFIGURABLE HAKR MODULAR LOUNGE**

Model Number	Description	Grade A Upholstery	Grade B/alfa Upholstery		Grade C Upholstery		Grade D Upholstery		Grade E Upholstery	
		/ COM	Seat	Main	Seat	Main	Seat	Main	Seat	Main
LHKRC	Hakr Lounge Club Chair, Configurable	1,685	+26	+39	+38	+57	+49	+74	+60	+90
LHKRMODNAC	Hakr Modular Lounge, Armless, Configurable	1,305	+16	+24	+24	+36	+31	+47	+38	+57
LHKRMOD2NA50C	Hakr Modular Lounge, 2-Seater, Armless, 50"W, Configurable	1,955	+26	+39	+38	+57	+49	+74	+60	+90
LHKRMOD2NA60C	Hakr Modular Lounge, 2-Seater, Armless, 60"W, Configurable	2,305	+33	+49	+48	+71	+62	+93	+75	+113
LHKRMOD3NAC	Hakr Modular Lounge, 3-Seater, Armless, Configurable	2,530	+38	+57	+56	+83	+73	+109	+88	+132
LHKRMODRHC	Hakr Modular Lounge, Single Arm, RH, Configurable	1,618	+23	+35	+34	+51	+44	+66	+53	+80
LHKRMODLHC	Hakr Modular Lounge, Single Arm, LH, Configurable	1,618	+23	+35	+34	+51	+44	+66	+53	+80
LHKRMODCRNRC	Hakr Modular Lounge, Corner, Square, Configurable	1,806	+27	+41	+40	+60	+52	+78	+63	+94
LHKRMODCRNR60C	Hakr Corner, Round, 60 degree, Configurable	2,355	+30	+45	+44	+65	+57	+86	+69	+104
LHKRMODCRNR90C	Hakr Corner, Round, 90 degree, Configurable	2,205	+27	+41	+40	+60	+52	+78	+63	+94

**Hakr Modular Lounge Tables**

**HAKR MODULAR LOUNGE TABLES PRODUCT INFORMATION**

Hakr modular lounge tables add the finishing touch to any modular lounge application. Allow the lounge furniture to work for you by integrating useful surface space with either the connecting or square tables. Preinstalled ganging brackets allow for simple installation and the freedom of reconfiguration as needs evolve.



**Club Chairs with Connecting Table**



**Square Table**

**FEATURES AND BENEFITS**

- Sustainably sourced hardwood frame.
- Durable steel legs available in Silver and Black.
- Tables are available in a variety of Grade A laminates.
- See Lounge Finish Options for more information.
- Ships fully assembled.

**SPECIFY**

- Laminate selection
- Leg paint color selection: black or silver

**PRODUCT SPECIFICATIONS**

<b>Model</b>	<b>Weight (lbs)</b>	<b>Height (Inches)</b>	<b>Width (Inches)</b>	<b>Depth (Inches)</b>
Hakr Connecting Table	25	15	14	29.5
Hakr Square Table	40	24	24	24

**Hakr Modular Lounge Tables**

**HAKR MODULAR LOUNGE TABLES MODELS AND OPTIONS**



**TL-HKRTBL**  
 Connecting Table  
 W 14" | D 29.5" | H 15"



**TL-HKRTBLSQR**  
 Square Table  
 W 24" | D 24" | H 15"

**HAKR MODULAR LOUNGE TABLES**

<b>Model Number</b>	<b>Description</b>	<b>List Price</b>
TL-HKRTBL	Hakr Connecting Table	1,565
TL-HKRTBLSQR	Hakr Square Table	1,790

**Hakr Lounge with Ledge**

**HAKR LOUNGE WITH LEDGE PRODUCT INFORMATION**

Hakr ledge takes the clean lines and sculpted profile of the Hakr lounge, and integrates a functional laminate ledge to enable collaboration and togetherness. The Hakr Modular lounge line features a combination of shapes and sizes, including rounded corners that create more organic configurations to support fellowship and connection. Take the lead with ledge.



**Hakr Lounge with Ledge**

**FEATURES AND BENEFITS**

- High-density, fixed foam cushions for extended support and comfort.
- Puzzle joinery frame in sustainably sourced hardwood ensures strength and longevity.
- Steel feet provide durability.
- 300 pound rating.
- CAL117 compliant.
- Ships fully assembled.
- Ledge field-installation required. Hardware included.
- Laminate ledge is 12”D and 1” thick, and sits at a comfortable working height of 29”.
- Weight limit on ledge is 100lbs.
- Ganging clips included.

**SPECIFY**

- Upholstery selection (configurable models include fabric selection for seat and separate fabric selection for surround)
- Laminate selection for ledge
- Leg paint color selection: black or silver

**PRODUCT SPECIFICATIONS**

<b>Model</b>	<b>Weight (lbs)</b>	<b>Height (Inches)</b>	<b>Width (Inches)</b>	<b>Depth (Inches)</b>	<b>Seat Height (Inches)</b>	<b>Seat Width (Inches)</b>	<b>Seat Depth (Inches)</b>
Hakr Lounge w/Ledge	65	31	26.5	42.5	17	26.5	21
Hakr Lounge w/Ledge, 2-Seater, 48”W	75	31	48.5	42.5	17	48.5	21
Hakr Lounge w/Ledge, 2-Seater, 60”W	90	31	60.5	42.5	17	60.5	21
Hakr Lounge w/Ledge, 3-Seater	110	31	72.5	42.5	17	72.5	21
Hakr Lounge w/Ledge, Round Corner, 60 degree	110	31	65.5	45.5	17	46.5	21
Hakr Lounge w/Ledge, Round Corner, 90 degree	100	31	67	44	17	40	21

**Hakr Lounge with Ledge**

**HAKR LOUNGE WITH LEDGE MODELS AND OPTIONS**



**LHKRLL**  
Armless Lounge with Ledge  
W 26.5" | D 42.5" | H 31"  
SW 26.5" | SD 21" | SH 17"



**LHKRLL248**  
2-Seater (48") with Ledge  
W 48.5" | D 42.5" | H 31"  
SW 48.5" | SD 21" | SH 17"



**LHKRLL260**  
2-Seater (60") with Ledge  
W 60.5" | D 42.5" | H 31"  
SW 60.5" | SD 21" | SH 17"



**LHKRLL3**  
3-Seater with Ledge  
W 72.5" | D 42.5" | H 31"  
SW 72.5" | SD 21" | SH 17"



**LHKRLLCRNR60**  
Corner Round 60" with Ledge  
W 66" | D 46" | H 31"  
SW 46.5" | SD 21" | SH 17"



**LHKRLLCRNR90**  
Corner Round 90" with Ledge  
W 67" | D 44" | H 31"  
SW 46.5" | SD 21" | SH 17"

**NON-CONFIGURABLE HAKR MODULAR LOUNGE**

Model Number	Description	Grade A Upholstery / COM	Grade B / alta Upholstery	Grade C Upholstery	Grade D Upholstery	Grade E Upholstery
LHKRLL	Hakr Lounge w/Ledge	2,063	+41	+60	+78	+94
LHKRLL248	Hakr Lounge w/Ledge, 2-Seater, 48"W	3,230	+65	+94	+123	+149
LHKRLL260	Hakr Lounge w/Ledge, 2-Seater, 60"W	3,488	+79	+114	+149	+181
LHKRLL3	Hakr Lounge w/Ledge, 3-Seater	3,713	+95	+139	+181	+220
LHKRLLCRNR60	Hakr Lounge w/Ledge, Round Corner, 60 degree	3,450	+75	+109	+143	+173
LHKRLLCRNR90	Hakr Lounge w/Ledge, Round Corner, 90 degree	3,400	+68	+99	+130	+157

**CONFIGURABLE HAKR MODULAR LOUNGE**

Model Number	Description	Grade A Upholstery / COM	Grade B/alta Upholstery		Grade C Upholstery		Grade D Upholstery		Grade E Upholstery	
			Seat	Remainder	Seat	Remainder	Seat	Remainder	Seat	Remainder
LHKRLLC	Hakr Lounge w/Ledge, Configurable	2,118	+16	+24	+24	+36	+31	+47	+38	+57
LHKRLL248C	Hakr Lounge w/Ledge, 2-Seater, 48"W, Configurable	3,285	+26	+39	+38	+57	+49	+74	+60	+90
LHKRLL260C	Hakr Lounge w/Ledge, 2-Seater, 60"W, Configurable	3,543	+31	+47	+46	+68	+60	+89	+72	+108
LHKRLL3C	Hakr Lounge w/Ledge, 3-Seater, Configurable	3,768	+38	+57	+56	+83	+73	+109	+88	+132
LHKRLLCRNR60C	Hakr Lounge w/Ledge, Round Corner, 60 degree, Configurable	3,505	+30	+45	+44	+65	+57	+86	+69	+104
LHKRLLCRNR90C	Hakr Lounge w/Ledge, Round Corner, 90 degree, Configurable	3,455	+27	+41	+40	+60	+52	+78	+63	+94

**HAKR PRIVACY LOUNGE PRODUCT INFORMATION**

Hakr Privacy Lounge integrates the clean lines and sculpted profile of the Hakr lounge into an inviting space for privacy and focus. Offered in multiple sizes, including single seats, 2-seater and 3-seater, equipped with either privacy panels or full privacy surrounds, the privacy lounge is a versatile addition to the Hakr line. Encourage quiet collaborative spaces or areas of respite and peace.



**Hakr Full Privacy Lounge, Club**



**Hakr Full Privacy Lounge, 2-Seater**

**FEATURES AND BENEFITS**

- High-density, fixed foam cushions for extended support and comfort.
- Puzzle joinery frame in sustainably sourced hardwood ensures strength and longevity.
- Steel feet provide durability.
- 300 pound rating.
- CAL117 compliant.
- Ships fully assembled.

**SPECIFY**

- Upholstery selection for seat/back and screen/surround
- Configurable models include separate fabric selections for seat, back and surround
- Leg paint color selection: black or silver

**PRODUCT SPECIFICATIONS**

<b>Model</b>	<b>Weight (lbs)</b>	<b>Height (Inches)</b>	<b>Width (Inches)</b>	<b>Depth (Inches)</b>	<b>Seat Height (Inches)</b>	<b>Seat Back Height (Inches)</b>	<b>Seat Width (Inches)</b>	<b>Seat Depth (Inches)</b>	<b>Screen Height (Inches)</b>
Hakr Privacy Lounge	65	48.5	26.5	31	17	31	26.5	21	48.5
Hakr Privacy Lounge, 2-Seater, 48"W	75	48.5	48.5	31	17	31	48.5	21	48.5
Hakr Privacy Lounge, 2-Seater, 60"W	90	48.5	60.5	31	17	31	60.5	21	48.5
Hakr Privacy Lounge, 3-Seater	100	48.5	72.5	31	17	31	72.5	21	48.5
Hakr Full Privacy Lounge	90	48.5	28.5	31	17	31	26.5	21	48.5
Hakr Full Privacy Lounge, 2-Seater, 48"W	110	48.5	50.5	31	17	31	48.5	21	48.5
Hakr Full Privacy Lounge, 2-Seater, 60"W	130	48.5	62.5	31	17	31	60.5	21	48.5
Hakr Full Privacy Lounge, 3-Seater	150	48.5	74.5	31	17	31	72.5	21	48.5

**Hakr Privacy Lounge**

**HAKR PRIVACY LOUNGE MODELS AND OPTIONS**



**LHKRPL**  
Privacy Lounge  
W 26.5" | D 31" | H 48.5"  
SW 26.5" | SD 21" | SH 17"



**LHKRPL248**  
2-Seater (48") Privacy Lounge  
W 48.5" | D 31" | H 48.5"  
SW 48.5" | SD 21" | SH 17"



**LHKRPL260**  
2-Seater (60") Privacy Lounge  
W 60.5" | D 31" | H 48.5"  
SW 60.5" | SD 21" | SH 17"



**LHKRPL3**  
3-Seater Privacy Lounge  
W 72.5" | D 31" | H 48.5"  
SW 72.5" | SD 21" | SH 17"

**NON-CONFIGURABLE HAKR PRIVACY LOUNGE**

Model Number	Description	Grade A Upholstery / COM	Grade B/alta Upholstery		Grade C Upholstery		Grade D Upholstery		Grade E Upholstery	
			Seat/Back	Screen	Seat/Back	Screen	Seat/Back	Screen	Seat/Back	Screen
LHKRPL	Hakr Privacy Lounge	2,250	+41	+27	+60	+40	+78	+52	+94	+63
LHKRPL248	Hakr Privacy Lounge, 2-Seater, 48"W	2,950	+63	+42	+92	+61	+120	+80	+146	+97
LHKRPL260	Hakr Privacy Lounge, 2-Seater, 60"W	3,350	+80	+53	+116	+67	+152	+101	+184	+123
LHKRPL3	Hakr Privacy Lounge, 3-Seater	4,100	+94	+63	+137	+91	+179	+119	+217	+145

**CONFIGURABLE HAKR PRIVACY LOUNGE**

Model Number	Description	Grade A Upholstery / COM	Grade B/alta Upholstery			Grade C Upholstery			Grade D Upholstery			Grade E Upholstery		
			Seat	Back	Screen	Seat	Back	Screen	Seat	Back	Screen	Seat	Back	Screen
LHKRPLC	Hakr Privacy Lounge, Configurable	2,305	+20	+20	+27	+30	+30	+40	+39	+39	+52	+47	+47	+63
LHKRPL248C	Hakr Privacy Lounge, 2-Seater, 48"W, Configurable	3,005	+32	+32	+42	+46	+46	+61	+60	+60	+80	+73	+73	+97
LHKRPL260C	Hakr Privacy Lounge, 2-Seater, 60"W, Configurable	3,405	+40	+40	+53	+58	+58	+77	+76	+76	+101	+92	+92	+123
LHKRPL3C	Hakr Privacy Lounge, 3-Seater, Configurable	4,155	+47	+47	+63	+68	+68	+91	+89	+89	+119	+108	+108	+145



**Hakr Full Privacy Lounge**

**HAKR FULL PRIVACY LOUNGE MODELS AND OPTIONS**



**LHKRFPL**  
Full Privacy Lounge  
W 28.5" | D 31" | H 48.5"  
SW 26.5" | SD 21" | SH 17"



**LHKRFPL248**  
2-Seater (48") Full Privacy Lounge  
W 50.5" | D 31" | H 48.5"  
SW 48.5" | SD 21" | SH 17"



**LHKRFPL260**  
2-Seater (60") Full Privacy Lounge  
W 62.5" | D 31" | H 48.5"  
SW 60.5" | SD 21" | SH 17"



**LHKRFPL3**  
3-Seater Full Privacy Lounge  
W 74.5" | D 31" | H 48.5"  
SW 72.5" | SD 21" | SH 17"

**NON-CONFIGURABLE HAKR PRIVACY LOUNGE**

Model Number	Description	Grade A Upholstery / COM	Grade B/alta Upholstery		Grade C Upholstery		Grade D Upholstery		Grade E Upholstery	
			Seat/Back	Screen	Seat/Back	Screen	Seat/Back	Screen	Seat/Back	Screen
LHKRFPL	Hakr Full Privacy Lounge	3,263	+38	+57	+56	+83	+73	+109	+88	+132
LHKRFPL248	Hakr Full Privacy Lounge, 2-Seater, 48"W	4,130	+64	+96	+93	+140	+122	+183	+148	+222
LHKRFPL260	Hakr Full Privacy Lounge, 2-Seater, 60"W	4,992	+75	+112	+109	+164	+143	+214	+173	+259
LHKRFPL3	Hakr Full Privacy Lounge, 3-Seater	5,945	+84	+126	+123	+184	+161	+241	+195	+292

**CONFIGURABLE HAKR PRIVACY LOUNGE**

Model Number	Description	Grade A Upholstery / COM	Grade B/alta Upholstery			Grade C Upholstery			Grade D Upholstery			Grade E Upholstery		
			Seat	Back	Screen	Seat	Back	Screen	Seat	Back	Screen	Seat	Back	Screen
LHKRFPLC	Hakr Full Privacy Lounge, Configurable	3,318	+19	+19	+57	+28	+28	+83	+36	+36	+109	+44	+44	+132
LHKRFPL248C	Hakr Full Privacy Lounge, 2-Seater, 48"W, Configurable	4,185	+32	+32	+96	+47	+47	+140	+61	+61	+183	+74	+74	+222
LHKRFPL260C	Hakr Full Privacy Lounge, 2-Seater, 60"W, Configurable	5,047	+37	+37	+112	+55	+55	+164	+71	+71	+214	+86	+86	+259
LHKRFPL3C	Hakr Full Privacy Lounge, 3-Seater, Configurable	6,000	+42	+42	+126	+61	+61	+184	+80	+80	+241	+97	+97	+292

**Hakr Benches & Ottomans**

**HAKR BENCHES & OTTOMANS PRODUCT INFORMATION**

Hakr benches and ottomans perfectly round out the Hakr line, bringing casual comfort into any space. Integrating benches of varying sizes and shapes creates an invitation for rest and relaxation, while the use of mobile ottomans can accommodate overflow seating when collaboration is the focus. These versatile products are the finishing puzzle piece to any lounge application.



**Hakr Ottoman**



**Hakr Bench**

**FEATURES AND BENEFITS**

- High-density, fixed foam cushions for extended support and comfort.
- Puzzle joinery frame in sustainably sourced hardwood ensures strength and longevity.
- Steel feet provide durability.
- 300 pound rating.
- CAL117 compliant.
- Ships fully assembled.
- Round ottomans ship two units per box and come with five 50mm casters preinstalled.

**SPECIFY**

- Upholstery selection for seat/back and screen/surround
- Leg paint color selection: black or silver

**PRODUCT SPECIFICATIONS**

<b>Model</b>	<b>Weight (lbs)</b>	<b>Height (Inches)</b>	<b>Width (Inches)</b>	<b>Depth (Inches)</b>
Hakr Round Ottoman, 18 Dia, Mobile	12	18	18" Diameter	
Hakr Round Ottoman, 24 Dia, Mobile	15	18	24" Diameter	
Hakr Bench, 30 Degree	40	17	48.5	26
Hakr Bench, 48"	40	17	48.5	22.5
Hakr Bench, 60"	45	17	60.5	22.5
Hakr Bench, 72"	50	17	22.5	17

**HAKR BENCHES & OTTOMANS MODELS AND OPTIONS**



**LHK18**  
Round Ottoman, 18" Mobile  
Diameter 18" | H 18"



**LHK24**  
Round Ottoman, 24" Mobile  
Diameter 24" | H 18"



**LHKB30**  
30° Curved Bench  
W 48.5" | D 22.5" | H 17"



**LHKB48**  
48" Bench  
W 48.5" | D 22.5" | H 17"



**LHKB60**  
60" Bench  
W 60.5" | D 22.5" | H 17"



**LHKB72**  
72" Bench  
W 72.5" | D 22.5" | H 17"

**HAKR BENCHES & OTTOMANS**

Model Number	Description	Grade A Upholstery / COM	Grade B / alta Upholstery	Grade C Upholstery	Grade D Upholstery	Grade E Upholstery
LHK18	Hakr Round Ottoman, 18 Dia, Mobile	720	+20	+30	+39	+47
LHK24	Hakr Round Ottoman, 24 Dia, Mobile	799	+27	+40	+52	+63
LHKB30	Hakr Bench, 30 Degree	1,150	+37	+55	+71	+86
LHKB48	Hakr Bench, 48"	1,323	+48	+69	+91	+110
LHKB60	Hakr Bench, 60"	1,521	+54	+79	+104	+126
LHKB72	Hakr Bench, 72"	1,795	+65	+94	+123	+149

**NV Lounge**

**NV LOUNGE PRODUCT INFORMATION**

NV Lounge features a minimalist design that doesn't sacrifice on comfort or function. With an intentionally angled back, this lounge line offers a slight recline for enhanced support, while high-density cushioning ensures extended comfort that works as long and as hard as you do. The added feature of an optional tablet arm on all three models in either the righthand or lefthand application, combines functionality with form. Get work done in style with NV.



**NV Club Chair with Tablet Arm**  
(left hand tablet shown)



**NV 2-Seater**

**FEATURES AND BENEFITS**

- High-density, fixed foam cushions for extended support and comfort.
- Puzzle joinery frame in sustainably sourced hardwood ensures strength and longevity.
- Tablet arm measures 10"W at the widest part and 16"L, and sits 2.44" above the chair arm.
- Steel legs available in black and silver.
- CAL117 compliant.
- 300 pound rating.
- Ships fully assembled. Optional tablet arms ship separately.

**SPECIFY**

- Upholstery selection
- Configurable models include fabric selection for seat and separate fabric selection for the main
- Leg paint color selection: black or silver

**PRODUCT SPECIFICATIONS**

Model	Weight (lbs)	Height (Inches)	Width (Inches)	Depth (Inches)	Seat Height (Inches)	Seat Width (Inches)	Seat Depth (Inches)	Arm Height (floor to top of arm, in inches)	Arm Height (top of seat to top of arm, in inches)
NV Club Chair	65	34	34	32.5	19	22.5	20.5	24.5	6.5
NV 2-Seater	100	34	58	32.5	19	46	20.5	24.5	6.5
NV 3-Seater	130	34	78.5	32.5	19	66.5	20.5	24.5	6.5

**NV LOUNGE MODELS AND OPTIONS**



**LNV1**  
Club Chair  
W 34" | D 33" | H 34"  
SW 22.5" | SD 20.5" | SH 19"



**LNV1TR**  
Club Chair, Right Tablet  
W 34" | D 33" | H 34"  
SW 22.5" | SD 20.5" | SH 19"



**LNV1TL**  
Club Chair, Left Tablet  
W 34" | D 33" | H 34"  
SW 22.5" | SD 20.5" | SH 19"



**LNV2**  
2-Seater  
W 54" | D 34" | H 33"  
SW 46" | SD 20.5" | SH 19"



**LNV2TR**  
2-Seater, Right Tablet  
W 54" | D 34" | H 33"  
SW 46" | SD 20.5" | SH 19"



**LNV2TL**  
2-Seater, Left Tablet  
W 54" | D 34" | H 33"  
SW 46" | SD 20.5" | SH 19"



**LNV3**  
3-Seater  
W 79" | D 33" | H 34"  
SW 66.5" | SD 20.5" | SH 19"



**LNV3TR**  
3-Seater, Right Tablet  
W 79" | D 33" | H 34"  
SW 66.5" | SD 20.5" | SH 19"



**LNV3TL**  
3-Seater, Left Tablet  
W 79" | D 33" | H 34"  
SW 66.5" | SD 20.5" | SH 19"

**NON-CONFIGURABLE NV MOBILE LOUNGE**

Model Number	Description	Grade A Upholstery / COM	Grade B / alta Upholstery	Grade C Upholstery	Grade D Upholstery	Grade E Upholstery
LNV1	NV Club Chair, Metal Legs	1,620	+65	+94	+123	+149
LNV1TR	NV Club Chair, Metal Legs, Tablet RH	2,250	+65	+94	+123	+149
LNV1TL	NV Club Chair, Metal Legs, Tablet LH	2,250	+65	+94	+123	+149
LNV2	NV 2-Seater, Metal Legs	2,350	+92	+134	+175	+212
LNV2TR	NV 2-Seater, Metal Legs, Tablet RH	2,980	+92	+134	+175	+212
LNV2TL	NV 2-Seater, Metal Legs, Tablet LH	2,980	+92	+134	+175	+212
LNV3	NV 3-Seater, Metal Legs	3,100	+112	+164	+214	+259
LNV3TR	NV 3-Seater, Metal Legs, Tablet RH	3,730	+112	+164	+214	+259
LNV3TL	NV 3-Seater, Metal Legs, Tablet LH	3,730	+112	+164	+214	+259

**NV Lounge**

**CONFIGURABLE NV MOBILE LOUNGE**

Model Number	Description	Grade A Upholstery / COM	Grade B/alta Upholstery		Grade C Upholstery		Grade D Upholstery		Grade E Upholstery	
			Seat	Main	Seat	Main	Seat	Main	Seat	Main
LNV1C	NV Club Chair, Metal Legs, Configurable	1,675	+19	+45	+28	+66	+37	+86	+45	+105
LNV1TRC	NV Club Chair, Metal Legs, Tablet RH, Configurable	2,305	+19	+45	+28	+66	+37	+86	+45	+105
LNV1TLC	NV Club Chair, Metal Legs, Tablet LH, Configurable	2,305	+19	+45	+28	+66	+37	+86	+45	+105
LNV2C	NV 2-Seater, Metal Legs, Configurable	2,405	+28	+64	+40	+94	+52	+122	+64	+149
LNV2TRC	NV 2-Seater, Metal Legs, Tablet RH, Configurable	3,035	+28	+64	+40	+94	+52	+122	+64	+149
LNV2TLC	NV 2-Seater, Metal Legs, Tablet LH, Configurable	3,035	+28	+64	+40	+94	+52	+122	+64	+149
LNV3C	NV 3-Seater, Metal Legs, Configurable	3,155	+34	+78	+49	+115	+64	+150	+78	+182
LNV3TRC	NV 3-Seater, Metal Legs, Tablet RH, Configurable	3,785	+34	+78	+49	+115	+64	+150	+78	+182
LNV3TLC	NV 3-Seater, Metal Legs, Tablet LH, Configurable	3,785	+34	+78	+49	+115	+64	+150	+78	+182

**SOFT LOUNGE PRODUCT INFORMATION**

The Soft lounge line offers a combination of unique curves and generous cushioning, adding a playful, comfortable aesthetic to any environment. Intricate details such as double-stitched seams, unique corner pleating, an upholstery wrapped platform and multiple leg finish options make this product line all the more versatile, fitting into the private office just as easily as into the open floorplan. Find comfort with Soft.



**Soft Club Chair**



**Soft 2-Seater**



**Soft 3-Seater**

**FEATURES AND BENEFITS**

- High-density, fixed foam cushions for extended support and comfort.
- Puzzle joinery frame in sustainably sourced hardwood ensures strength and longevity.
- 8”H legs are available in either steel or wood for an upcharge. Legs are 2” in diameter.
- Paint options are black and silver.
- Wood leg options are Field Elm, Aimtoo Savatre or Trytoo Savatre; incurs a \$180 list upcharge.
- CAL117 compliant.
- 300 pound rating.
- Legs ship unassembled.

**SPECIFY**

- Upholstery selection
- Configurable models include fabric selection for seat and separate fabric selection for the main
- Leg finish selection (painted or wood)
- Leg color selection: black and silver

**PRODUCT SPECIFICATIONS**

<b>Model</b>	<b>Weight (lbs)</b>	<b>Height (Inches)</b>	<b>Width (Inches)</b>	<b>Depth (Inches)</b>	<b>Seat Height (Inches)</b>	<b>Seat Width (Inches)</b>	<b>Seat Depth (Inches)</b>	<b>Arm Height (floor to top of arm, in inches)</b>	<b>Arm Height (top of seat to top of arm, in inches)</b>
Soft Lounge Club Chair	85	29	40	33	17	21	22	25	8.25
Soft Lounge 2-Seater	130	29	66	33	17	48	22	25	8.25
Soft Lounge 3-Seater	170	29	87.5	33	17	69.5	22	25	8.25

**Product Details**

**LEG FINISH OPTIONS**



**Silver (Steel)**



**Black (Steel)**



**Aimtoo Savatre\* (Wood)**



**Field Elm\* (Wood)**



**Tryroo Savatre\* (Wood)**

\*Wood legs on all Soft lounge models incur an upcharge of \$180 per model.

**CASTER & BEZEL DETAILS**



**Locking Caster**



**Black Bezel**



**Silver Bezel**



**SOFT LOUNGE MODELS AND OPTIONS**



**LSOFT1**  
Soft Lounge Club Chair  
W 40" | D 33" | H 29"  
SW 21" | SD 22" | SH 17"



**LSOFT2**  
Soft Lounge 2-Seater  
W 66" | D 33" | H 29"  
SW 48" | SD 22" | SH 17"



**LSOFT3**  
Soft Lounge 3-Seater  
W 87.5" | D 33" | H 29"  
SW 69.5" | SD 22" | SH 17"

**NON-CONFIGURABLE SOFT LOUNGE**

Model Number	Description	Grade A Upholstery / COM	Grade B / alta Upholstery	Grade C Upholstery	Grade D Upholstery	Grade E Upholstery
LSOFT1	Soft Lounge Club Chair	2,460	+68	+99	+130	+157
LSOFT2	Soft Lounge 2-Seater	3,300	+102	+149	+194	+236
LSOFT3	Soft Lounge 3-Seater	4,150	+119	+174	+227	+275

**CONFIGURABLE SOFT LOUNGE**

Model Number	Description	Grade A Upholstery / COM	Grade B / alta Upholstery		Grade C Upholstery		Grade D Upholstery		Grade E Upholstery	
			Seat	Main	Seat	Main	Seat	Main	Seat	Main
LSOFT1C	Soft Lounge Club Chair, Configurable	2,515	+20	+48	+30	+69	+39	+91	+47	+110
LSOFT2C	Soft Lounge 2-Seater, Configurable	3,355	+31	+71	+45	+104	+58	+136	+71	+165
LSOFT3C	Soft Lounge 3-Seater, Configurable	4,205	+36	+83	+52	+122	+68	+159	+83	+193

**Soft Mobile Lounge**

**SOFT LOUNGE PRODUCT INFORMATION**

The Soft mobile lounge line offers the same curves and details as the Soft lounge, but on unique show-stopping casters that drive collaboration and conversation. Intricate details such as double-stitched seams, unique corner pleating, an upholstery wrapped platform and the added feature of mobility make Soft Mobile Lounge the definition of versatility and functionality. Get moving with Soft Mobile Lounge.



**Soft Mobile Club Chair**

**FEATURES AND BENEFITS**

- High-density, fixed foam cushions for extended support and comfort.
- Puzzle joinery frame in sustainably sourced hardwood ensures strength and longevity.
- Casters are 7.64”H. Front 2 casters are non-locking; rear 2 casters are locking.
- CAL117 compliant.
- 300 pound rating.
- Casters are shipped unassembled.

**SPECIFY**

- Upholstery selection
- Configurable models include fabric selection for seat and separate fabric selection for the main

**PRODUCT SPECIFICATIONS**

<b>Model</b>	<b>Weight (lbs)</b>	<b>Height (Inches)</b>	<b>Width (Inches)</b>	<b>Depth (Inches)</b>	<b>Seat Height (Inches)</b>	<b>Seat Width (Inches)</b>	<b>Seat Depth (Inches)</b>	<b>Arm Height (floor to top of arm, in inches)</b>	<b>Arm Height (top of seat to top of arm, in inches)</b>
Soft Lounge Mobile Club Chair	85	28.5	40	33	16.5	21	22	25	8.25
Soft Lounge Mobile 2-Seater	130	28.5	66	33	16.5	48	22	25	8.25
Soft Lounge Mobile 3-Seater	170	28.5	87.5	33	16.5	69.5	22	25	8.25

**SOFT MOBILE LOUNGE MODELS AND OPTIONS**



**LSOFT1M**  
Soft Mobile Lounge Club Chair  
W 40" | D 33" | H 29"  
SW 21" | SD 22" | SH 17"



**LSOFT2M**  
Soft Mobile Lounge 2-Seater  
W 66" | D 33" | H 29"  
SW 48" | SD 22" | SH 17"



**LSOFT3M**  
Soft Mobile Lounge 3-Seater  
W 87.5" | D 33" | H 29"  
SW 69.5" | SD 22" | SH 17"

**NON-CONFIGURABLE SOFT MOBILE LOUNGE**

Model Number	Description	Grade A Upholstery / COM	Grade B / alta Upholstery	Grade C Upholstery	Grade D Upholstery	Grade E Upholstery
LSOFT1M	Soft Lounge Mobile Club Chair	2,700	+68	+99	+130	+157
LSOFT2M	Soft Lounge Mobile 2-Seater	3,540	+102	+149	+194	+236
LSOFT3M	Soft Lounge Mobile 3-Seater	4,390	+119	+174	+227	+275

**CONFIGURABLE SOFT MOBILE LOUNGE**

Model Number	Description	Grade A Upholstery / COM	Grade B / alta Upholstery		Grade C Upholstery		Grade D Upholstery		Grade E Upholstery	
			Seat	Main	Seat	Main	Seat	Main	Seat	Main
LSOFT1MC	Soft Lounge Mobile Club Chair, Configurable	2,755	+20	+48	+30	+69	+39	+91	+47	+110
LSOFT2MC	Soft Lounge Mobile 2-Seater, Configurable	3,595	+31	+71	+45	+104	+58	+136	+71	+165
LSOFT3MC	Soft Lounge Mobile 3-Seater, Configurable	4,445	+36	+83	+52	+122	+68	+159	+83	+193

**Soft Modular Lounge**

**SOFT MODULAR LOUNGE PRODUCT INFORMATION**

The Soft modular lounge offers limitless applications to support collaboration and connection. This statement of line features multiple sizes and shapes including rounded and angular corners designed to achieve whimsical and organic shapes that bring people together. Integrating the same unique details including double-stitched seams, corner pleating and an upholstery-wrapped platform in addition to steel and wood leg options, Soft Modular Lounge delivers the comfort of home to the workplace.



**Soft Modular Lounge**

**FEATURES AND BENEFITS**

- High-density, fixed foam cushions for extended support and comfort.
- Puzzle joinery frame in sustainably sourced hardwood ensures strength and longevity.
- 8”H legs are available in either steel or wood for an upcharge. Legs are 2” in diameter.
- Paint options are black and silver.
- Wood leg options are Field Elm, Aimtoo Savatre or Trytoo Savatre; incurs a \$180 list upcharge.
- CAL117 compliant.
- 300 pound rating.
- Legs ship unassembled.
- Ganging clips included.

**SPECIFY**

- Upholstery selection
- Leg finish selection (painted or wood)
- Leg color selection: black and silver

**PRODUCT SPECIFICATIONS**

<b>Model</b>	<b>Weight (lbs)</b>	<b>Height (Inches)</b>	<b>Width (Inches)</b>	<b>Depth (Inches)</b>	<b>Seat Height (Inches)</b>	<b>Seat Width (Inches)</b>	<b>Seat Depth (Inches)</b>	<b>Arm Height (floor to top of arm, in inches)</b>	<b>Arm Height (top of seat to top of arm, in inches)</b>
Soft Modular Lounge	75	29	37	33	17	37	22	N/A	N/A
Soft Modular Lounge, 2-Seater	120	29	66	33	17	66	22	N/A	N/A
Soft Modular Lounge, Single Arm, Right Hand	80	29	38	33	17	66	22	25	8.25
Soft Modular Lounge, Single Arm, Left Hand	80	29	38	33	17	66	22	25	8.25
Soft Modular Lounge Corner	80	29	33	33	17	24	22	25	8.25
Soft Modular Lounge Corner, 90 degree	120	29	62	35.5	17	48.5	22	N/A	N/A
Soft Modular Lounge Corner, 45 degree	100	29	60.5	36.5	17	53	22	N/A	N/A

**SOFT MODULAR LOUNGE MODELS AND OPTIONS**



**LSOFMOD**  
Modular Lounge  
W 37" | D 33" | H 29"  
SW 37" | SD 22" | SH 17"



**LSOFMOD2**  
Modular Lounge, 2-Seater  
W 66" | D 33" | H 29"  
SW 266" | SD 22" | SH 17"



**LSOFMODRH**  
Single Arm Modular Lounge, Right Hand  
W 38" | D 33" | H 29"  
SW 29" | SD 22" | SH 17"



**LSOFMODLH**  
Single Arm Modular Lounge, Left Hand  
W 38" | D 33" | H 29"  
SW 29" | SD 22" | SH 17"



**LSOFMODCRNR**  
Modular Lounge, Corner  
W 33" | D 33" | H 29"  
SW 29" | SD 22" | SH 17"



**LSOFMODCRNR90**  
Modular Lounge, Corner 90°  
W 62" | D 36" | H 29"  
SW 48.5" | SD 22" | SH 17"



**LSOFMODCRNR45**  
Modular Lounge, Corner 45°  
W 60.5" | D 36.5" | H 29"  
SW 53" | SD 22" | SH 17"

**NON-CONFIGURABLE SOFT MODULAR LOUNGE**

Model Number	Description	Grade A Upholstery / COM	Grade B / alta Upholstery	Grade C Upholstery	Grade D Upholstery	Grade E Upholstery
LSOFMOD	Soft Modular Lounge	2,001	+61	+89	+117	+141
LSOFMOD2	Soft Modular Lounge, 2-Seater	2,755	+85	+124	+162	+197
LSOFMODRH	Soft Modular Lounge, Single Arm, RH	2,200	+61	+89	+117	+141
LSOFMODLH	Soft Modular Lounge, Single Arm, LH	2,200	+61	+89	+117	+141
LSOFMODCRNR	Soft Modular Lounge Corner	2,400	+61	+89	+117	+141
LSOFMODCRNR90	Soft Modular Lounge Corner, 90 degree	3,000	+112	+164	+214	+259
LSOFMODCRNR45	Soft Modular Lounge Corner, 45 degree	3,100	+112	+164	+214	+259

**Soft Privacy & Full Privacy Lounge**

**SOFT PRIVACY & FULL PRIVACY LOUNGE PRODUCT INFORMATION**

The Soft Privacy lounge perfectly rounds out the Soft line with the addition of functional privacy features. This statement of line offers single and two-seater solutions with either privacy panels or full privacy surrounds, and shares the same uniquely Soft details including double-stitched seams, corner pleating, and an upholstery-wrapped platform in addition to steel and wood leg options. Collaborate quietly or work privately in these ideal privacy lounge solutions.



**Soft Privacy Lounge, 2-Seater with Back, Privacy Panels**



**Soft Privacy Lounge, 2-Seater**

**FEATURES AND BENEFITS**

- High-density, fixed foam cushions for extended support and comfort.
- Puzzle joinery frame in sustainably sourced hardwood ensures strength and longevity.
- 8”H legs are available in either steel or wood for an upcharge. Legs are 2” in diameter.
- Paint options are black and silver.
- Wood leg options are Field Elm, Aimtoo Savatre or Trytoo Savatre; incurs a \$180 list upcharge.
- CAL117 compliant.
- 300 pound rating.
- Legs and privacy panels ship unassembled. Hardware included. See online installation instructions for details.

**SPECIFY**

- Upholstery selection for seat and back
- Upholstery selection for privacy screen or surround
- Leg finish selection (painted or wood)
- Leg color selection: black and silver

**PRODUCT SPECIFICATIONS**

<b>Model</b>	<b>Weight (lbs)</b>	<b>Height (Inches)</b>	<b>Width (Inches)</b>	<b>Depth (Inches)</b>	<b>Seat Height (Inches)</b>	<b>Seat Back Height (Inches)</b>	<b>Seat Width (Inches)</b>	<b>Seat Depth (Inches)</b>	<b>Screen Height (Inches)</b>
Soft Privacy Lounge, Armless	90	50.5	37.5	34	17	29	37	22	50.5
Soft Privacy Lounge, Armless, 2-Seater	135	50.5	66	34	17	29	66	22	50.5
Soft Full Privacy Lounge, Armless	100	50.5	39.5	34	17	29	37	22	50.5
Soft Full Privacy Lounge, Armless, 2-Seater	145	50.5	68	34	17	29	66	22	50.5

**Soft Privacy & Full Privacy Lounge**

**SOFT PRIVACY & FULL PRIVACY LOUNGE MODELS AND OPTIONS**



**LSOFTPL**  
Soft Privacy Lounge, Armless  
W 37.5" | D 34" | H 50.5"  
SW 37" | SD 22" | SH 17"



**LSOFTPL2**  
Soft Privacy Lounge, Armless, 2-Seater  
W 66" | D 34" | H 50.5"  
SW 66" | SD 22" | SH 17"



**LSOFTFPL**  
Soft Full Privacy Lounge, Armless  
W 39.5" | D 34" | H 50.5"  
SW 37" | SD 22" | SH 17"



**LSOFTFPL2**  
Soft Full Privacy Lounge, Armless, 2-Seater  
W 68" | D 34" | H 50.5"  
SW 66" | SD 22" | SH 17"

**NON-CONFIGURABLE HAKR PRIVACY LOUNGE**

Model Number	Description	Grade A Upholstery / COM	Grade B/alta Upholstery		Grade C Upholstery		Grade D Upholstery		Grade E Upholstery	
			Main	Screen	Main	Screen	Main	Screen	Main	Screen
LSOFTPL	Soft Privacy Lounge, Armless	2,830	+57	+38	+83	+56	+109	+73	+132	+88
LSOFTPL2	Soft Privacy Lounge, Armless, 2-Seater	3,821	+84	+56	+122	+81	+159	+106	+193	+129
LSOFTFPL	Soft Full Privacy Lounge, Armless	4,967	+57	+93	+83	+135	+109	+176	+132	+214
LSOFTFPL2	Soft Full Privacy Lounge, Armless, 2-Seater	6,308	+84	+116	+122	+171	+159	+223	+193	+271

**Soft Benches & Ottomans**

**SOFT BENCHES & OTTOMANS PRODUCT INFORMATION**

Hakr benches and ottomans perfectly round out the Hakr line, bringing casual comfort into any space. Integrating benches of varying sizes and shapes creates an invitation for rest and relaxation, while the use of mobile ottomans can accommodate overflow seating when collaboration is the focus. These versatile products are the finishing puzzle piece to any lounge application.



**Soft Mobile Ottoman**



**Soft 2-Seater Ottoman**

**FEATURES AND BENEFITS**

- High-density, fixed foam cushions for extended support and comfort.
- Puzzle joinery frame in sustainably sourced hardwood ensures strength and longevity.
- 8”H legs are available in either steel or wood for an upcharge. Legs are 2” in diameter.
- Paint options are black and silver.
- Wood leg options are Field Elm, Aimtoo Savatre or Trytoo Savatre; incurs a \$180 list upcharge.
- CAL117 compliant.
- 300 pound rating.
- Legs ship unassembled.

**SPECIFY**

- Upholstery selection
- Leg finish selection (painted or wood)
- Leg color selection

**PRODUCT SPECIFICATIONS**

<b>Model</b>	<b>Weight (lbs)</b>	<b>Height (Inches)</b>	<b>Width (Inches)</b>	<b>Depth (Inches)</b>	<b>Seat Height (Inches)</b>
Soft Lounge Ottoman	30	17	40	32	17
Soft Lounge Ottoman, 2-Seater	40	17	65.5	32	17
Soft Lounge Ottoman, 3-Seater	55	17	85.5	32	17
Soft Round Ottoman, 16”H	15	16	20” Diameter		—
Soft Round Mobile Ottoman, 18”H	16	18.5	20” Diameter		—



**SOFT BENCHES & OTTOMANS MODELS AND OPTIONS**



**LSOFT-B1**  
Ottoman  
W 40" | D 32" | H 17"



**LSOFT-B2**  
Ottoman, 2-Seater  
W 65.5" | D 32" | H 17"



**LSOFT-B3**  
Ottoman, 3-Seater  
W 85.5" | D 32" | H 17"



**LSOFT-R16**  
Round Ottoman  
Diameter 20" | H 16"



**LSOFT-R18**  
Round Ottoman, 18" Mobile  
Diameter 20" | H 18"

**SOFT BENCHES & OTTOMANS**

<b>Model Number</b>	<b>Description</b>	<b>Grade A Upholstery / COM</b>	<b>Grade B / alta Upholstery</b>	<b>Grade C Upholstery</b>	<b>Grade D Upholstery</b>	<b>Grade E Upholstery</b>
LSOFT-B1	Soft Lounge Ottoman	1,450	+54	+79	+104	+126
LSOFT-B2	Soft Lounge Ottoman, 2-Seater	1,900	+78	+114	+149	+181
LSOFT-B3	Soft Lounge Ottoman, 3-Seater	2,400	+95	+139	+181	+220
LSOFT-R16	Soft Round Ottoman, 16"H	850	+17	+25	+32	+39
LSOFT-R18	Soft Round Mobile Ottoman, 18"H	875	+17	+25	+32	+39

**Prisma Tables**

**PRISMA TABLES PRODUCT INFORMATION**

Add interest and function into any setting with the addition of the Prisma tables. These occasional tables, available in three sizes, bring the sense of home into the office environment, giving lounge and collaborative applications a balanced aesthetic. Achieve spaces in which to gather and connect, while adding a modern twist with the geometrical metal bases available in two powder coated paint colors that promise durability and longevity.



**Large Coffee Table**



**Small Coffee Table**



**Side Table**

**FEATURES AND BENEFITS**

- Powder coated metal frame provides durability and stability.
- Table tops are available in a variety of Grade A laminates.
- See Lounge Finish Options for more information.

**SPECIFY**

- Laminate selection
- Leg paint color selection: black or silver

**PRODUCT SPECIFICATIONS**

<b>Model</b>	<b>Weight (lbs)</b>	<b>Height (Inches)</b>	<b>Width (Inches)</b>	<b>Depth (Inches)</b>
Prisma Large Coffee Table	60	17	42	42
Prisma Small Coffee Table	40	17	32	32
Prisma Side Table	25	21	20	20

**PRISMA TABLES MODELS AND OPTIONS**



**TL-PRTB1**  
Large Coffee Table  
W 42" | D 42" | H 17"



**TL-PRTB2**  
Small Coffee Table  
W 32" | D 32" | H 17"



**TL-PRTB3**  
Side Table  
W 20" | D 20" | H 21"

**PRISMA LOUNGE TABLES**

<b>Model Number</b>	<b>Description</b>	<b>List Price</b>
TL-PRTB1	Prisma Large Coffee Table	1,950
TL-PRTB2	Prisma Small Coffee Table	1,650
TL-PRTB3	Prisma Side Table	1,150

**LB Lounge**

**LB LOUNGE PRODUCT INFORMATION**

Easily create a range of welcoming environments with the LB Lounge. This versatile collection of collaborative seating, ottomans, and tables supports corporate, healthcare or educational environments, as well as booths for dining or meeting. With ample seat dimensions and convenient open storage, guests remain comfortable and clutter is controlled.

Define spaces or create boundaries with the bold, solid design. Blend finishes and apply a range of upholstery options to create a custom look. It's all possible with LB Lounge.

**Note:** LB Lounge seat cushions are installed to base with screws, back seat cushions are installed using Velcro strips. See installation instructions for more details.



**LB Lounge Seating and Ottomans with Calibrate for LB End Tables**  
**(Please use Calibrate Price List for information on complementary tables)**

**FEATURES AND BENEFITS**

- Available with one, two, three seats
- One depth, three back heights and several width dimensions
- Open or solid laminate base
- Optional LB Ledge surface for working space
- Choice of 20+ Grade A laminates
- Standard with leveling glides
- CAL117 compliant
- Choose one upholstery for the entire unit or up to six for the three-seater unit
- LB Lounge has a weight capacity of 300lbs
- Please use the Calibrate Price List for additional and complementary tables

**PRODUCT SPECIFICATIONS**

Model	Weight (lbs)	Height (Inches)	Width (Inches)	Depth (Inches)	Seat Height (Inches)	Seat Width (Inches)	Seat Depth (Inches)
LB Lounge 1-Seater	114 - 204	34 - 50	30	30	17	—	21
LB Lounge 2-Seater	114 - 204	34 - 50	36 - 60	30	17	—	21
LB Lounge 3-Seater	199 - 249	34 - 50	66 - 72	30	17	—	21
LB Lounge Backless Unit	—	18	30 - 72	30	—	—	—
LB Lounge Corner Unit	—	34, 42, 50	30	30	—	—	—
LB Ledge	—	—	48 - 72	13 - 15	—	—	—

**LB LOUNGE 1-SEATER (2-CUSHION) MODELS AND OPTIONS**



Configurable LB Lounge  
Open Base 1-Seater (2-Cushion)



Configurable LB Lounge  
Solid Base 1-Seater (2-Cushion)

Model Number	Description	Base	Laminate	Fabric	Base Model Price
Varies by Size	Configurable 1-Seater (2-Cushion)	Laminate Open or Solid Base	Choice of Grade A Laminate	Choice of 2 Fabrics (Seat x1 and Back x1)	Varies by Size

**CONFIGURABLE LB LOUNGE  
OPEN BASE 1-SEATER (2-CUSHION) OPTIONS**

H	W	D	Model Number	Grade A Upholstery/COM	Grade B Upholstery (Per Cushion)	Grade C Upholstery (Per Cushion)	Grade D Upholstery (Per Cushion)	Grade E Upholstery (Per Cushion)
34	30	30	F-SSC343030C	1,149	+23	+45	+68	+102
42	30	30	F-SSC423030C	1,227	+28	+54	+81	+121
50	30	30	F-SSC503030C	1,308	+30	+59	+87	+130

**CONFIGURABLE LB LOUNGE  
SOLID BASE 1-SEATER (2-CUSHION) OPTIONS**

H	W	D	Model Number	Grade A Upholstery/COM	Grade B Upholstery (Per Cushion)	Grade C Upholstery (Per Cushion)	Grade D Upholstery (Per Cushion)	Grade E Upholstery (Per Cushion)
34	30	30	F-SSS343030C	1,262	+23	+45	+68	+102
42	30	30	F-SSS423030C	1,351	+28	+54	+81	+121
50	30	30	F-SSS503030C	1,439	+30	+59	+87	+130

**LB LOUNGE OPEN 1-SEATER (2-CUSHION) UPHOLSTERY SPECIFICATIONS**

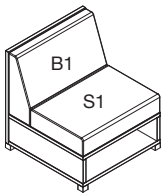

When ordering a unit with more than one upholstery please indicate the upholstery selection along with the particular "cushion code" to ensure that the selected upholsteries are applied to the correct cushion. See image for example. For pricing examples see chart below:

Example	Model Number	List	Cushion B1	Cushion S1	Total List
1. 34H x 30W 1-Seater (2 Cushion) with Grade A & B Cushions	F-SSC343030C	1,149	+0 (Grade A)	+23 (Grade B)	\$1,172
2. 42H x 30W 1-Seater (2 Cushion) with Grade B Cushions	F-SSC423030C	1,227	+28 (Grade B)	+28 (Grade B)	\$1,283
3. 50H x 30W 1-Seater (2 Cushion) with Grade B & C Cushions	F-SSC503030C	1,308	+30 (Grade B)	+59 (Grade C)	\$1,397

**2-Seaters**

**LB LOUNGE 2-SEATER (4-CUSHION) MODELS AND OPTIONS**



Configurable LB Lounge  
Open Base 2-Seater (4-Cushion)



Configurable LB Lounge  
Solid Base 2-Seater (4-Cushion)

Model Number	Description	Base	Laminate	Fabric	Base Model Price
Varies by Size	Configurable 2-Seater (4-Cushion)	Laminate Open or Solid Base	Choice of Grade A Laminate	Choice of 4 Fabrics (Seat x2 and Back x2)	Varies by Size

**CONFIGURABLE LB LOUNGE  
OPEN BASE 2-SEATER (4-CUSHION) OPTIONS**

H	W	D	Model Number	Grade A Upholstery/ COM	Grade B Upholstery (Per Cushion)	Grade C Upholstery (Per Cushion)	Grade D Upholstery (Per Cushion)	Grade E Upholstery (Per Cushion)
34	36	30	F-SSC343630C	1,190	+23	+45	+68	+102
34	42	30	F-SSC344230C	1,299	+23	+45	+68	+102
34	48	30	F-SSC344830C	1,413	+23	+45	+68	+102
34	54	30	F-SSC345430C	1,521	+23	+45	+68	+102
34	60	30	F-SSC346030C	1,632	+23	+45	+68	+102
42	36	30	F-SSC423630C	1,272	+28	+54	+81	+121
42	42	30	F-SSC424230C	1,387	+28	+54	+81	+121
42	48	30	F-SSC424830C	1,504	+28	+54	+81	+121
42	54	30	F-SSC425430C	1,617	+28	+54	+81	+121
42	60	30	F-SSC426030C	1,733	+28	+54	+81	+121
50	36	30	F-SSC503630C	1,352	+30	+59	+87	+130
50	42	30	F-SSC504230C	1,473	+30	+59	+87	+130
50	48	30	F-SSC504830C	1,596	+30	+59	+87	+130
50	54	30	F-SSC505430C	1,716	+30	+59	+87	+130
50	60	30	F-SSC506030C	1,834	+30	+59	+87	+130

**CONFIGURABLE LB LOUNGE  
SOLID BASE 2-SEATER (4-CUSHION) OPTIONS**

H	W	D	Model Number	Grade A Upholstery/ COM	Grade B Upholstery (Per Cushion)	Grade C Upholstery (Per Cushion)	Grade D Upholstery (Per Cushion)	Grade E Upholstery (Per Cushion)
34	36	30	F-SSS343630C	1,310	+23	+45	+68	+102
34	42	30	F-SSS344230C	1,430	+23	+45	+68	+102
34	48	30	F-SSS344830C	1,554	+23	+45	+68	+102
34	54	30	F-SSS345430C	1,674	+23	+45	+68	+102
34	60	30	F-SSS346030C	1,796	+23	+45	+68	+102
42	36	30	F-SSS423630C	1,399	+28	+54	+81	+121
42	42	30	F-SSS424230C	1,526	+28	+54	+81	+121
42	48	30	F-SSS424830C	1,656	+28	+54	+81	+121
42	54	30	F-SSS425430C	1,781	+28	+54	+81	+121
42	60	30	F-SSS426030C	1,906	+28	+54	+81	+121
50	36	30	F-SSS503630C	1,487	+30	+59	+87	+130
50	42	30	F-SSS504230C	1,620	+30	+59	+87	+130
50	48	30	F-SSS504830C	1,756	+30	+59	+87	+130
50	54	30	F-SSS505430C	1,887	+30	+59	+87	+130
50	60	30	F-SSS506030C	2,017	+30	+59	+87	+130

**LB LOUNGE 2-SEATER (4-CUSHION) UPHOLSTERY SPECIFICATIONS**

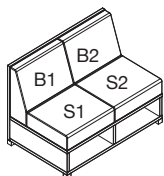

When ordering a unit with more than one upholstery please indicate the upholstery selection along with the particular "cushion code" to ensure that the selected upholsteries are applied to the correct cushion. See image for example. For pricing examples see chart below:

Example	Model Number	List	Cushion B1	Cushion B2	Cushion S1	Cushion S2	Total List
1. 34H x 36W 2-Seater (4-Cushion) with Grade A & B Cushions	F-SSC343630C	1,190	+0 (Grade A)	+23 (Grade B)	+0 (Grade A)	+23 (Grade B)	\$1,236
2. 42H x 36W 2-Seater (4-Cushion) with Grade B, C & D Cushions	F-SSC423630C	1,272	+28 (Grade B)	+28 (Grade B)	+54 (Grade C)	+81 (Grade D)	\$1,463
3. 50H x 36W 2-Seater (4-Cushion) with Grade B, C, D & E Cushions	F-SSC503630C	1,352	+30 (Grade B)	+59 (Grade C)	+59 (Grade C)	+130 (Grade E)	\$1,630

**LB LOUNGE 3-SEATER (6-CUSHION) MODELS AND OPTIONS**



Configurable LB Lounge  
Open Base 3-Seater (6-Cushion)



Configurable LB Lounge  
Solid Base 3-Seater (6-Cushion)

Model Number	Description	Base	Laminate	Fabric	Base Model Price
Varies by Size	Configurable 3-Seater (6-Cushion)	Laminate Open or Solid Base	Choice of Grade A Laminate	Choice of 6 Fabrics (Seat x3 and Back x3)	Varies by Size

CONFIGURABLE LB LOUNGE OPEN BASE 3-SEATER (6-CUSHION) OPTIONS									
H	W	D	Model Number	Grade A Upholstery/COM	Grade B Upholstery (Per Cushion)	Grade C Upholstery (Per Cushion)	Grade D Upholstery (Per Cushion)	Grade E Upholstery (Per Cushion)	
34	66	30	F-SSC346630C	1,880	+23	+45	+68	+102	
34	72	30	F-SSC347230C	2,183	+23	+45	+68	+102	
42	66	30	F-SSC426630C	2,001	+28	+54	+81	+121	
42	72	30	F-SSC427230C	2,309	+28	+54	+81	+121	
50	66	30	F-SSC506630C	2,121	+30	+59	+87	+130	
50	72	30	F-SSC507230C	2,435	+30	+59	+87	+130	

CONFIGURABLE LB LOUNGE SOLID BASE 3-SEATER (6-CUSHION) OPTIONS									
H	W	D	Model Number	Grade A Upholstery/COM	Grade B Upholstery (Per Cushion)	Grade C Upholstery (Per Cushion)	Grade D Upholstery (Per Cushion)	Grade E Upholstery (Per Cushion)	
34	66	30	F-SSS346630C	2,067	+23	+45	+68	+102	
34	72	30	F-SSS347230C	2,403	+23	+45	+68	+102	
42	66	30	F-SSS426630C	2,201	+28	+54	+81	+121	
42	72	30	F-SSS427230C	2,542	+28	+54	+81	+121	
50	66	30	F-SSS506630C	2,333	+30	+59	+87	+130	
50	72	30	F-SSS507230C	2,679	+30	+59	+87	+130	

**LB LOUNGE 3-SEATER (6-CUSHION) UPHOLSTERY SPECIFICATIONS**

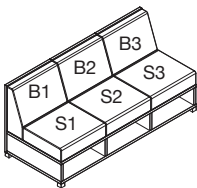

When ordering a unit with more than one upholstery please indicate the upholstery selection along with the particular "cushion code" to ensure that the selected upholsteries are applied to the correct cushion. See image for example. For pricing examples see chart below:

Example	Model Number	List	Cushion B1	Cushion B2	Cushion B3	Cushion S1	Cushion S2	Cushion S3	Total List
1. 34H x 66W 3-Seater (6-Cushion) with Grade A, B, C, D & E Cushions	F-SSC346630C	1,880	+0 (Grade A)	+23 (Grade B)	+45 (Grade C)	+68 (Grade D)	+102 (Grade E)	+102 (Grade E)	\$2,220
2. 42H x 66W 3-Seater (6-Cushion) with Grade B & C Cushions	F-SSC426630C	2,001	+28 (Grade B)	+28 (Grade B)	+28 (Grade B)	+54 (Grade C)	+54 (Grade C)	+54 (Grade C)	\$2,247
3. 50H x 66W 3-Seater (6-Cushion) with Grade C, D & E Cushions	F-SSC506630C	2,121	+59 (Grade C)	+130 (Grade E)	+59 (Grade C)	+87 (Grade D)	+59 (Grade C)	+87 (Grade D)	\$2,602

**Backless Units**

**LB LOUNGE BACKLESS UNIT MODELS AND OPTIONS**



Configurable LB Lounge Backless Unit  
Open or Solid Base (1-Cushion)



Configurable LB Lounge Backless Unit  
Open or Solid Base (2-Cushion)

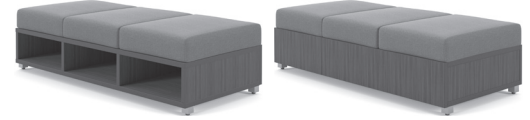

Configurable LB Lounge Backless Unit  
Open or Solid Base (3-Cushion)

Model Number	Description	Base	Laminate	Fabric	Base Model Price
Varies by Size	Configurable Backless Unit (1, 2 or 3-Cushions)	Choice of Laminate Open or Solid Base	Choice of Grade A Laminate	Choice of Fabric (Varies by Size)	Varies by Size

**CONFIGURABLE LB LOUNGE BACKLESS UNIT  
OPEN BASE (1-CUSHION) OPTIONS**

H	W	D	Model Number	Grade A	Grade B	Grade C	Grade D	Grade E
				Upholstery/ COM	Upholstery (Per Cushion)	Upholstery (Per Cushion)	Upholstery (Per Cushion)	Upholstery (Per Cushion)
18	30	30	F-SBCR303030C	840	+23	+45	+68	+102

**CONFIGURABLE LB LOUNGE BACKLESS UNIT  
SOLID BASE (1-CUSHION) OPTIONS**

H	W	D	Model Number	Grade A	Grade B	Grade C	Grade D	Grade E
				Upholstery/ COM	Upholstery (Per Cushion)	Upholstery (Per Cushion)	Upholstery (Per Cushion)	Upholstery (Per Cushion)
18	30	30	F-SCCR303030C	922	+23	+45	+68	+102

**CONFIGURABLE LB LOUNGE BACKLESS UNIT  
OPEN BASE (2-CUSHION) OPTIONS**

H	W	D	Model Number	Grade A	Grade B	Grade C	Grade D	Grade E
				Upholstery/ COM	Upholstery (Per Cushion)	Upholstery (Per Cushion)	Upholstery (Per Cushion)	Upholstery (Per Cushion)
18	36	30	F-SBCR303630C	870	+23	+45	+68	+102
18	42	30	F-SBCR304230C	950	+23	+45	+68	+102
18	48	30	F-SBCR304830C	1,032	+23	+45	+68	+102
18	54	30	F-SBCR305430C	1,113	+23	+45	+68	+102
18	60	30	F-SBCR306030C	1,193	+23	+45	+68	+102

**CONFIGURABLE LB LOUNGE BACKLESS UNIT  
SOLID BASE (2-CUSHION) OPTIONS**

H	W	D	Model Number	Grade A	Grade B	Grade C	Grade D	Grade E
				Upholstery/ COM	Upholstery (Per Cushion)	Upholstery (Per Cushion)	Upholstery (Per Cushion)	Upholstery (Per Cushion)
18	36	30	F-SCCR303630C	958	+23	+45	+68	+102
18	42	30	F-SCCR304230C	1,047	+23	+45	+68	+102
18	48	30	F-SCCR304830C	1,136	+23	+45	+68	+102
18	54	30	F-SCCR305430C	1,223	+23	+45	+68	+102
18	60	30	F-SCCR306030C	1,313	+23	+45	+68	+102

**CONFIGURABLE LB LOUNGE BACKLESS UNIT  
OPEN BASE (3-CUSHION) OPTIONS**

H	W	D	Model Number	Grade A	Grade B	Grade C	Grade D	Grade E
				Upholstery/ COM	Upholstery (Per Cushion)	Upholstery (Per Cushion)	Upholstery (Per Cushion)	Upholstery (Per Cushion)
18	66	30	F-SBCR306630C	1,373	+23	+45	+68	+102
18	72	30	F-SBCR307230C	1,597	+23	+45	+68	+102

**CONFIGURABLE LB LOUNGE BACKLESS UNIT  
SOLID BASE (3-CUSHION) OPTIONS**

H	W	D	Model Number	Grade A	Grade B	Grade C	Grade D	Grade E
				Upholstery/ COM	Upholstery (Per Cushion)	Upholstery (Per Cushion)	Upholstery (Per Cushion)	Upholstery (Per Cushion)
18	66	30	F-SCCR306630C	1,512	+23	+45	+68	+102
18	72	30	F-SCCR307230C	1,757	+23	+45	+68	+102

**LB LOUNGE BACKLESS UNIT UPHOLSTERY SPECIFICATIONS**

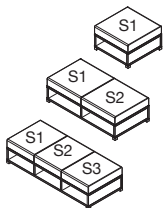

When ordering a unit with more than one upholstery please indicate the upholstery selection along with the particular "cushion code" to ensure that the selected upholsteries are applied to the correct cushion. See image for example. For pricing examples see chart below:

Example	Model Number	List	Cushion S1	Cushion S2	Cushion S3	Total List
1. 30H x 30W x 30D Backless Unit (1-Cushion) with Grade B Cushion	F-SBCR303030C	840	+23 (Grade B)	-	-	\$863
2. 30H x 48W x 30D Backless Unit (2-Cushion) with Grade A & B Cushions	F-SBCR304830C	1,032	+23 (Grade B)	+23 (Grade B)	-	\$1,078
2. 30H x 66W x 30D Backless Unit (3-Cushion) with Grade B, C & C Cushions	F-SBCR306630C	1,373	+23 (Grade B)	+45 (Grade C)	+45 (Grade C)	\$1,486



**LB LOUNGE CORNER UNIT (3-CUSHION) MODELS AND OPTIONS**



Configurable LB Lounge Left Corner Unit  
Open Base or Solid Base (3-Cushion)

Configurable LB Lounge Right Corner Unit  
Open Base or Solid Base (3-Cushion)

Model Number	Description	Base	Laminate	Fabric	Base Model Price
Varies by Size	Configurable Corner Unit (3-Cushion)	Laminate Open or Solid Base	Choice of Grade A Laminate	Choice of 3 Fabrics (Seat x1 and Back x2)	Varies by Size

**Note: See specification guide pages for placement and use instructions.**

**CONFIGURABLE LB LOUNGE LEFT CORNER UNIT  
OPEN BASE, REAR OVERLAY (3-CUSHION) OPTIONS**

H	W	D	Model Number	Grade A Upholstery/COM	Grade B Upholstery (Per Cushion)	Grade C Upholstery (Per Cushion)	Grade D Upholstery (Per Cushion)	Grade E Upholstery (Per Cushion)
34	30	30	F-SSCR343030L	1,773	+23	+45	+68	+102
42	30	30	F-SSCR423030L	2,013	+23	+45	+68	+102
50	30	30	F-SSCR503030L	2,433	+23	+45	+68	+102

**CONFIGURABLE LB LOUNGE RIGHT CORNER UNIT  
OPEN BASE, REAR OVERLAY (3-CUSHION) OPTIONS**

H	W	D	Model Number	Grade A Upholstery/COM	Grade B Upholstery (Per Cushion)	Grade C Upholstery (Per Cushion)	Grade D Upholstery (Per Cushion)	Grade E Upholstery (Per Cushion)
34	30	30	F-SSCR343030R	1,773	+23	+45	+68	+102
42	30	30	F-SSCR423030R	2,013	+23	+45	+68	+102
50	30	30	F-SSCR503030R	2,433	+23	+45	+68	+102

**CONFIGURABLE LB LOUNGE LEFT CORNER UNIT  
SOLID BASE, REAR OVERLAY (3-CUSHION) OPTIONS**

H	W	D	Model Number	Grade A Upholstery/COM	Grade B Upholstery (Per Cushion)	Grade C Upholstery (Per Cushion)	Grade D Upholstery (Per Cushion)	Grade E Upholstery (Per Cushion)
34	30	30	F-SSCR343030L	1,800	+23	+45	+68	+102
42	30	30	F-SSCR423030L	2,039	+23	+45	+68	+102
50	30	30	F-SSCR503030L	2,458	+23	+45	+68	+102

**CONFIGURABLE LB LOUNGE RIGHT CORNER UNIT  
SOLID BASE, REAR OVERLAY (3-CUSHION) OPTIONS**

H	W	D	Model Number	Grade A Upholstery/COM	Grade B Upholstery (Per Cushion)	Grade C Upholstery (Per Cushion)	Grade D Upholstery (Per Cushion)	Grade E Upholstery (Per Cushion)
34	30	30	F-SSCR343030R	1,800	+23	+45	+68	+102
42	30	30	F-SSCR423030R	2,039	+23	+45	+68	+102
50	30	30	F-SSCR503030R	2,458	+23	+45	+68	+102

**LB LOUNGE CORNER UNIT (3-CUSHION) UPHOLSTERY SPECIFICATIONS**

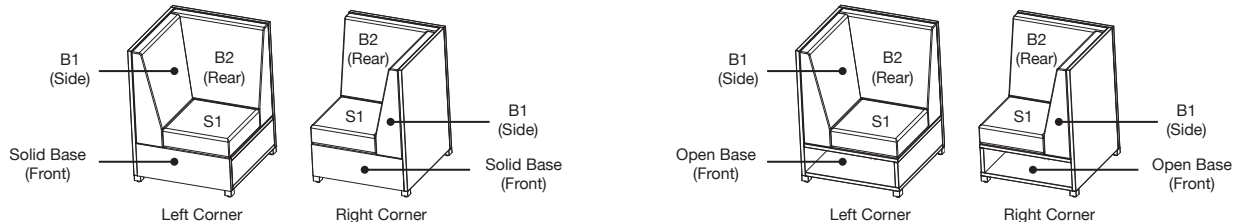

When ordering a unit with more than one upholstery please indicate the upholstery selection along with the particular "cushion code" to ensure that the selected upholsteries are applied to the correct cushion. See image for example. For pricing examples see chart below:

Example	Model Number	List	Cushion B1	Cushion B2	Cushion S1	Total List
1. 34H x 30W Left Corner Unit (3-Cushion) with Grade A & B Cushions	F-SSCR343030L	1,773	+0 (Grade A)	+23 (Grade B)	+0 (Grade A)	\$1,796
2. 42H x 30W Right Corner Unit (3-Cushion) with Grade B, C & D Cushions	F-SSCR423030R	2,039	+23 (Grade B)	+23 (Grade B)	+45 (Grade C)	\$2,130
3. 50H x 330W Left Corner Unit (3-Cushion) with Grade B, C, D & B Cushions	F-SSCR503030L	2,433	+23 (Grade B)	+45 (Grade C)	+45 (Grade C)	\$2,546

**Ledges**

**LB LEDGE**

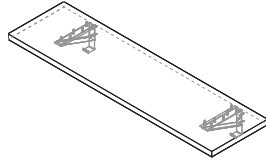

LB Ledge 13" Deep - Installs to Rear of Lounge

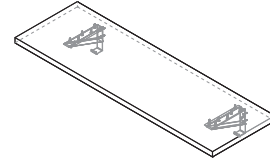

LB Ledge 15" Deep - Installs to Top of Lounge

Model Number	Description	Install Locations	Laminate	Base Model Price
Varies by Size	LB Ledge	Rear of Lounge (13 Deep) or Top of Lounge (15 Deep)	Choice of Laminate	Varies by Size

13" DEEP LB LEDGE					
D	W	Install Location	Model Number	List Price	Grade C Laminate
13	48	Rear of Lounge	F-LBLL1348	961	+21
13	54	Rear of Lounge	F-LBLL1354	974	+24
13	60	Rear of Lounge	F-LBLL1360	1,297	+24
13	66	Rear of Lounge	F-LBLL1366	1,313	+27
13	72	Rear of Lounge	F-LBLL1372	1,635	+27

15" DEEP LB LEDGE					
D	W	Install Location	Model Number	List Price	Grade C Laminate
15	48	Top of Lounge	F-LBLL1548	979	+21
15	54	Top of Lounge	F-LBLL1554	996	+24
15	60	Top of Lounge	F-LBLL1560	1,320	+24
15	66	Top of Lounge	F-LBLL1566	1,338	+27
15	72	Top of Lounge	F-LBLL1572	1,663	+27

*Note: Support bracket and bag hook available in your choice of paint selection. LB Lounge Ledge discounts with AIS Seating.*

**LB LEDGE SPECIFICATION GUIDE**

13" deep LB Ledge kits are designed to install to the rear of the LB Lounge unit:

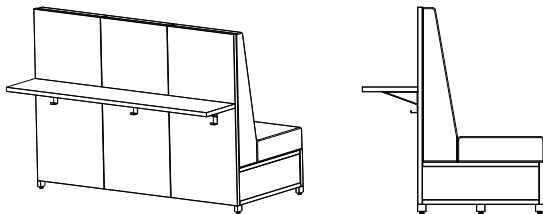

15" deep LB Ledge kits are designed to install to the top of the LB Lounge unit:

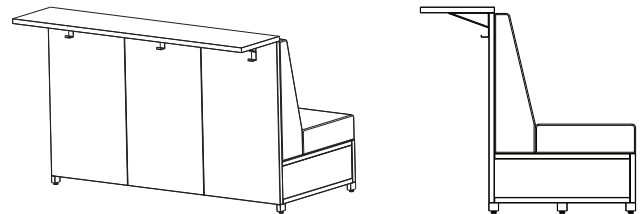

**FINISH SELECTIONS**

- Color Selection for Edge
- Laminate Selection for Worksurface
- Paint Selection for Cantilever supports

**LB LOUNGE CORNER UNIT (3-CUSHION) SPECIFICATION GUIDE**

LB Lounge Corner Units can be used to finish the ends (bookend) of a run of LB Lounge couches.

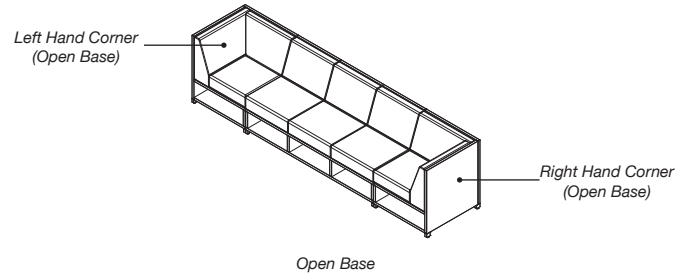
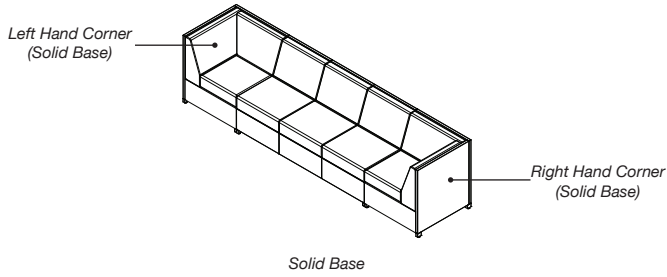

It is generally advised to use LB Lounge Corner Units with the same open/solid bases as the adjacent pieces. This will give the best appearance, should the peripheral LB Lounge units move away from the central piece for some reason.

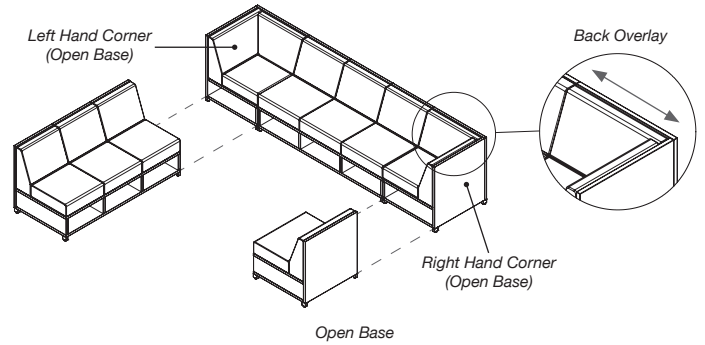
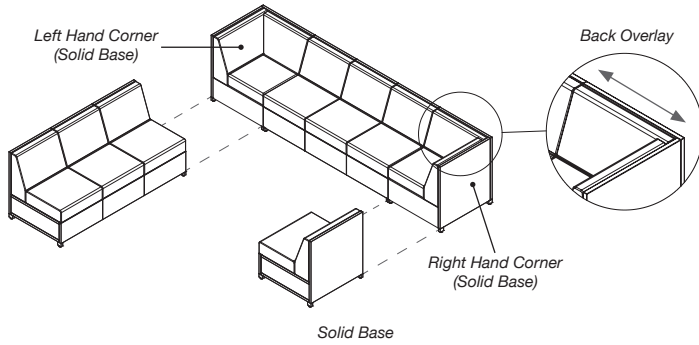

LB Lounge Corner units are designed to have a continuous rear overlay along the back of the central unit. This gives the assembly a cleanest appearance in most situations. To change the overlay direction, swap the left and right handed corner units.

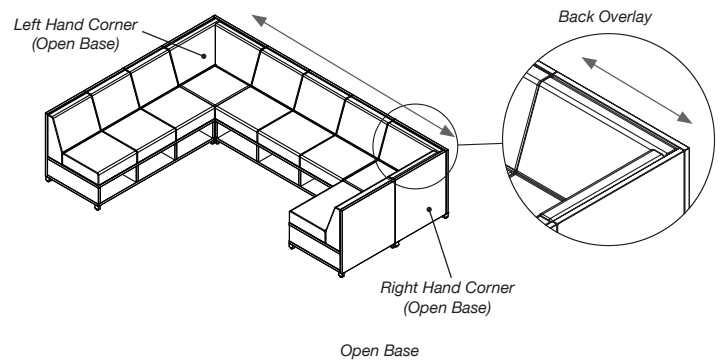
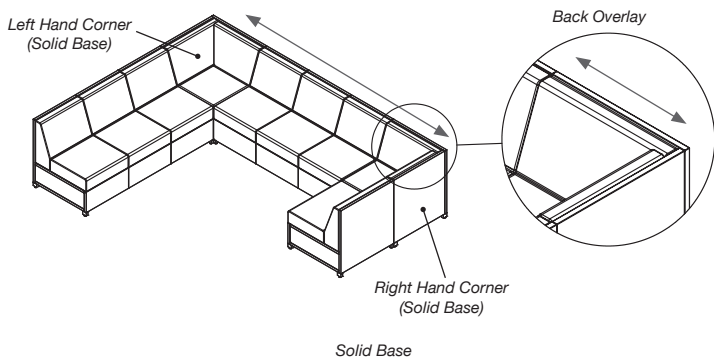

**Ottomans**

**LB OTTOMAN MODELS AND OPTIONS**



LB Ottoman with Feet  
(18"H x 30"W x 30"D Shown)

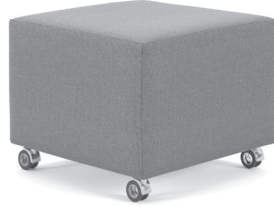

LB Ottoman with Casters  
(18"H x 30"W x 30"D Shown)

Model Number	Description	Base	Laminate	Fabric	Base Model Price
Varies by Size	LB Ottoman	With Feet or Casters	None	Choice of Fabric	Varies by Fabric Grade

**Note:**

When handling/moving LB Ottoman make sure that it is lifted and placed into location. Dragging or tipping the LB Ottoman may cause feet underneath to break off. Casters are not field retrofittable on existing models.

LB OTTOMAN WITH FEET									
H	W	D	Model Number	Grade A/ COM	Grade B	Grade C	Grade D	Grade E	
18	24	24	F-VO182424	856	+63	+127	+190	+253	
18	30	24	F-VO183024	931	+63	+127	+190	+253	
18	30	30	F-VO183030	1,038	+63	+127	+190	+253	

LB OTTOMAN WITH CASTERS									
H	W	D	Model Number	Grade A/ COM	Grade B	Grade C	Grade D	Grade E	
18	24	24	F-VO182424C	942	+63	+127	+190	+253	
18	30	24	F-VO183024C	1,056	+63	+127	+190	+253	
18	30	30	F-VO183030C	1,166	+63	+127	+190	+253	

**LB Lounge Corner and End Tables**

<b>LB LOUNGE CORNER TABLE</b>						
			Powered		Non-Powered	
H	W	D	Model Number	List	Model Number	List
18	30	30	F-CCT203030P	1,330	F-CCT203030	750

<b>LB LOUNGE END TABLE</b>						
			Powered		Non-Powered	
H	W	D	Model Number	List	Model Number	List
18	24	30	F-CET202430P	1,315	F-CET202430	745

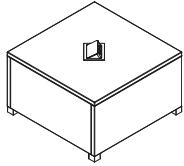

Powered

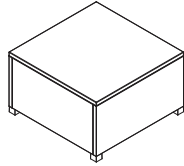

Non-Powered

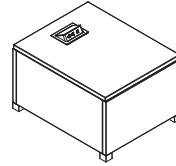

Powered

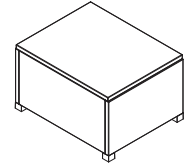

Non-Powered

**Specify**

**Notes**

- Laminate Selection for Table
- Color Selection for Power Unit (White/White or White/Silver)

- Powered tables feature an Ashley Duo Air power unit with two outlets and two USB ports.

**Chatham Cove**

**PRODUCT INFORMATION**

Chatham Cove supports the need for alternative workplaces within the open plan. Whether individual users or small groups gather, Chatham Cove ensures they have all they need for comfort, focus, and convenience. Beautiful laminate and the structural O-Leg base combine to create this light scale work lounge. Specify alone, or combine in a variety of ways to support your needs.

Chatham Cove delivers choices. The line includes a single seat lounge that can be specified in pairs to create a two-seat application. Choose from low, medium or high laminate privacy surrounds and two- or three- sided configurations.



**FEATURES AND BENEFITS**

- Single Seat
- Two- or Three-sided Surround
- Two-sided single seats can be ganged together to create a settee application
- Surround height: 34", 50" or 58"
- Storage cubby (24.25"W x 10.5D x 16.75H) for personal items
- Optional integrated power with three outlets and two USBs
- PET or fabric insert for additional acoustical performance (mounted above shelf)
- Chatham Cove has a weight capacity of 300lbs per seat

**PRODUCT SPECIFICATIONS**

<b>Model</b>	<b>Weight (lbs)</b>	<b>Height (Inches)</b>	<b>Width (Inches)</b>	<b>Depth (Inches)</b>	<b>Seat Height (Inches)</b>	<b>Seat Depth (Inches)</b>	<b>Shelf Depth (Inches)</b>
Chatham Cove 2-Sided	116 - 130	34, 50, 58	42	30	34	18	10.5
Chatham Cove 3-Sided	160 - 188	34, 50, 58	42	30	34	18	10.5

**CHATHAM COVE 2-SIDED MODELS AND OPTIONS**



Configurable Chatham Cove  
2-Sided Left



Configurable Chatham Cove  
2-Sided Right

Model Number	Description	Base	Laminate	Fabric	Base Model Price
Varies by Size	Configurable 1-Seater (2-Sided)	O-Legs (Choice of Paint Color)	Choice of Grade A Laminate	Choice of 2 Fabrics (Seat x1 and Back x1)	Varies by Size

CONFIGURABLE CHATHAM COVE 2-SIDED LEFT POWERED OPTIONS								
H	W	D	Model Number	Grade A Upholstery/COM	Grade B Upholstery (Per Cushion)	Grade C Upholstery (Per Cushion)	Grade D Upholstery (Per Cushion)	Grade E Upholstery (Per Cushion)
34	42	30	F-CC2PL344230	2,708	+23	+45	+68	+102
50	42	30	F-CC2PL504230	3,430	+23	+45	+68	+102
58	42	30	F-CC2PL584230	3,530	+23	+45	+68	+102

CONFIGURABLE CHATHAM COVE 2-SIDED RIGHT POWERED OPTIONS								
H	W	D	Model Number	Grade A Upholstery/COM	Grade B Upholstery (Per Cushion)	Grade C Upholstery (Per Cushion)	Grade D Upholstery (Per Cushion)	Grade E Upholstery (Per Cushion)
34	42	30	F-CC2PR344230	2,708	+23	+45	+68	+102
50	42	30	F-CC2PR504230	3,430	+23	+45	+68	+102
58	42	30	F-CC2PR584230	3,530	+23	+45	+68	+102

CONFIGURABLE CHATHAM COVE 2-SIDED LEFT NON-POWERED OPTIONS								
H	W	D	Model Number	Grade A Upholstery/COM	Grade B Upholstery (Per Cushion)	Grade C Upholstery (Per Cushion)	Grade D Upholstery (Per Cushion)	Grade E Upholstery (Per Cushion)
34	42	30	F-CC2NL344230	2,507	+23	+45	+68	+102
50	42	30	F-CC2NL504230	3,184	+23	+45	+68	+102
58	42	30	F-CC2NL584230	3,282	+23	+45	+68	+102

CONFIGURABLE CHATHAM COVE 2-SIDED RIGHT NON-POWERED OPTIONS								
H	W	D	Model Number	Grade A Upholstery/COM	Grade B Upholstery (Per Cushion)	Grade C Upholstery (Per Cushion)	Grade D Upholstery (Per Cushion)	Grade E Upholstery (Per Cushion)
34	42	30	F-CC2NR344230	2,507	+23	+45	+68	+102
50	42	30	F-CC2NR504230	3,184	+23	+45	+68	+102
58	42	30	F-CC2NR584230	3,282	+23	+45	+68	+102

Note: Select choice of paint color option for O-Leg (Grade C +28)

**CHATHAM COVE UPHOLSTERY SPECIFICATIONS**

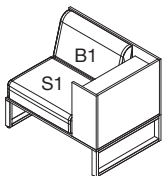

When ordering a unit with more than one upholstery please indicate the upholstery selection along with the particular "cushion code" to ensure that the selected upholsteries are applied to the correct cushion. See image for example. For pricing examples see chart below:

Example	Model Number	List	Cushion B1	Cushion S1	O-Leg Paint	Total List
1. 34H x 42W x 30D 2-Sided Left Powered with Grade A & B Cushions	F-CC2PL344230	2,708	+0 (Grade A)	+23 (Grade B)	+0 (Grade A)	2,731
2. 34H x 42W x 30D 2-Sided Left Non-Powered with Grade B Cushions	F-CC2NR344230	2,507	+23 (Grade B)	+23 (Grade B)	+25 (Grade C)	2,578
3. 58H x 42W x 30D 2-Sided Left Powered with Grade B & C Cushions	F-CC2PL584230	3,530	+23 (Grade B)	+45 (Grade C)	+25 (Grade C)	3,623

**3-Sided Covers**

**CHATHAM COVE 3-SIDED MODELS AND OPTIONS**



Configurable Chatham Cove  
3-Sided Left



Configurable Chatham Cove  
3-Sided Right

Model Number	Description	Base	Laminate	Fabric	Base Model Price
Varies by Size	Configurable 1-Seater (3-Sided)	O-Legs (Choice of Paint Color)	Choice of Grade A Laminate	Choice of 2 Fabrics (Seat x1 and Back x1)	Varies by Size

**CONFIGURABLE CHATHAM COVE 3-SIDED LEFT POWERED OPTIONS**

H	W	D	Model Number	Grade A Upholstery/ COM	Grade B Upholstery (Per Cushion)	Grade C Upholstery (Per Cushion)	Grade D Upholstery (Per Cushion)	Grade E Upholstery (Per Cushion)
34	42	30	F-CC3PL344230	2,780	+23	+45	+68	+102
50	42	30	F-CC3PL504230	3,520	+23	+45	+68	+102
58	42	30	F-CC3PL584230	3,619	+23	+45	+68	+102

**CONFIGURABLE CHATHAM COVE 3-SIDED RIGHT POWERED OPTIONS**

H	W	D	Model Number	Grade A Upholstery/ COM	Grade B Upholstery (Per Cushion)	Grade C Upholstery (Per Cushion)	Grade D Upholstery (Per Cushion)	Grade E Upholstery (Per Cushion)
34	42	30	F-CC3PR344230	2,780	+23	+45	+68	+102
50	42	30	F-CC3PR504230	3,520	+23	+45	+68	+102
58	42	30	F-CC3PR584230	3,619	+23	+45	+68	+102

**CONFIGURABLE CHATHAM COVE 3-SIDED LEFT NON-POWERED OPTIONS**

H	W	D	Model Number	Grade A Upholstery/ COM	Grade B Upholstery (Per Cushion)	Grade C Upholstery (Per Cushion)	Grade D Upholstery (Per Cushion)	Grade E Upholstery (Per Cushion)
34	42	30	F-CC3NL344230	2,580	+23	+45	+68	+102
50	42	30	F-CC3NL504230	3,273	+23	+45	+68	+102
58	42	30	F-CC3NL584230	3,372	+23	+45	+68	+102

**CONFIGURABLE CHATHAM COVE 3-SIDED RIGHT NON-POWERED OPTIONS**

H	W	D	Model Number	Grade A Upholstery/ COM	Grade B Upholstery (Per Cushion)	Grade C Upholstery (Per Cushion)	Grade D Upholstery (Per Cushion)	Grade E Upholstery (Per Cushion)
34	42	30	F-CC3NR344230	2,580	+23	+45	+68	+102
50	42	30	F-CC3NR504230	3,273	+23	+45	+68	+102
58	42	30	F-CC3NR584230	3,372	+23	+45	+68	+102

Note: Select choice of paint color option for O-Leg (Grade C +28)

**CHATHAM COVE UPHOLSTERY SPECIFICATIONS**

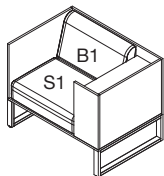

When ordering a unit with more than one upholstery please indicate the upholstery selection along with the particular "cushion code" to ensure that the selected upholsteries are applied to the correct cushion. See image for example. For pricing examples see chart below:

Example	Model Number	List	Cushion B1	Cushion S1	O-Leg Paint	Total List
1. 34H x 42W x 30D 2-Sided Left Powered with Grade A & B Cushions	F-CC3PL344230	2,780	+0 (Grade A)	+23 (Grade B)	+0 (Grade A)	2,803
2. 34H x 42W x 30D 2-Sided Left Non-Powered with Grade B Cushions	F-CC3NL344230	2,580	+23 (Grade B)	+23 (Grade B)	+25 (Grade C)	2,651
3. 58H x 42W x 30D 2-Sided Left Powered with Grade B & C Cushions	F-CC3PL584230	3,619	+23 (Grade B)	+45 (Grade C)	+25 (Grade C)	3,712



**CHATHAM COVE INSERTS**

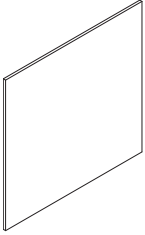

Chatham Cove Insert

Model Number	Description	Finish	Base Model Price
Varies by Size	Chatham Cove Insert	Choice of PET or Fabric Color	Varies by Size

CHATHAM COVE INSERTS								
W	D	Material	Model Number	List Price	Grade B Fabric	Grade C Fabric	Grade D Fabric	COM Fabric
50	30	PET*	F-TPET5030	429	-	-	-	-
50	30	Fabric	F-TACK5030	771	+0	+38	+68	-20
58	30	PET*	F-TPET5830	490	-	-	-	-
58	30	Fabric	F-TACK5830	832	+0	+38	+68	-20

\*Choice of PET Colors: Lite Grey, Medium Grey, Tan or Vibrant Blue.

**CHATHAM COVE INSERT SPECIFICATION GUIDE**

Comes with non-marring mounting adhesive for install. Inserts are field replaceable.

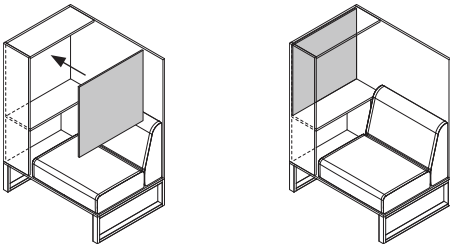

**Volker Cubes and Nesting Table**

**PRODUCT INFORMATION**

AIS Volker Cubes and tables offer user friendly, comfortable seating and meeting solutions for today’s work and learning environments. Whether used for impromptu collaborative spaces, guest seating in workstations, or casual waiting areas, the Volker Cube’s versatile design will complement your office. Its welcoming, simple and smart design makes the Volker Cube the perfect addition to any environment.

The Volker Cube can be easily and discretely tucked away when not in use, or effortlessly pulled out when ready to use. The Volker Cube features a sleek design with the upholstery fabric of choice to complete the design of your workspace. The cube features hubless casters allowing for ease of motion as well as adding an attractive design element. The Volker table is customizable offering an assortment of laminate options. The Volker table provides the perfect nesting compartment for the cube, providing convenient storage.



**Volker Cubes with Nesting Table (with Writable Laminate Top)**

**FEATURES AND BENEFITS**

- Grade A through COM upholstery options
- Easily tucks into the table allowing for a small footprint
- 18” Deep x 18” Wide x 18” High (incl. casters) cube
- Nesting table: 19” High x 37” Wide x 37” Deep
- Easy to move
- 20 Grade A laminate options for table base
- Table top can be any Grade A or HPL (matching edgeband only available for Grade A). For laminate reference the Calibrate Price List
- Please use the Calibrate Price List for additional and complementary tables
- Cubes have a 300lbs. rating

**PRODUCT SPECIFICATIONS**

<b>Model</b>	<b>Weight (lbs)</b>	<b>Height (Inches)</b>	<b>Width (Inches)</b>	<b>Depth (Inches)</b>	<b>Seat Height (w/casters, in Inches)</b>	<b>Seat Width (Inches)</b>	<b>Shelf Depth (Inches)</b>
Volker Cube	36	18	18	18	18	18	18

**Volker Cube and Nesting Table**

**VOLKER CUBE MODELS**



Standard Volker Cube



Volker Cube (x4) with Nesting Table

Model Number	Description	Laminate	Fabric	Base Model Price
F-CUBE181818	Standard Volker Cube	None	Choice of Fabric	Varies by Fabric Grade
F-CUBENEST	Volker Cube (x4) with Nesting Table	Choice of Laminate for Nesting Table	Choice of Fabric for each Cube	Varies by Fabric Grade

STANDARD VOLKER CUBE								
H	W	D	Model Number	Grade A/ COM	Grade B	Grade C	Grade D	Grade E
18	18	18	F-CUBE181818	697	+38	+88	+137	+224

FOUR VOLKER CUBES WITH NESTING TABLE								
H	W	D	Model Number	Grade A/ COM	Grade B	Grade C	Grade D	Grade E
19 1/4	37 3/8	37 3/8	F-CUBENEST	4,083	+152	+352	+548	+896

**VOLKER CUBE UPHOLSTERY SPECIFICATIONS**

When ordering multiple upholsteries in different Grades for the four Volker Cubes with Nesting Table the cost of the unit will be calculated according to the following example:

F-CUBENEST with one Grade A Volker Cube, one Grade B Volker Cube, one Grade C Volker Cube and one Grade D Volker Cube upholstery selection:  
 \$3,888 (Grade A base price) + \$38 (1/4 of Grade B upcharge) + \$88 (1/4 of Grade C upcharge) + \$137 (1/4 of Grade D upcharge) = List Price of \$4,151.

**VOLKER CUBE NESTING TABLE**

H	W	D	Model Number	List
19.25	37 3/8	37 3/8	F-CNTABLE	635

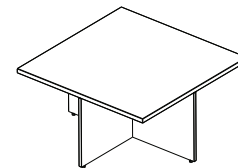

Specify	Notes
<ul style="list-style-type: none"> <li>Laminate Selection for Base and Top</li> <li>Edgeband Selection for Top</li> </ul>	<ul style="list-style-type: none"> <li>See below for example configuration.</li> <li>Volker Cubes sold separately. See Seating Price List for Volker Cube pricing and options.</li> </ul>

**Laptop Table and Sit to Stand Mobile Desk**

**LAPTOP TABLE**

H	W	D	Model Number	List	Grade C Paint
25.94	19	12	T-LT	550	+25

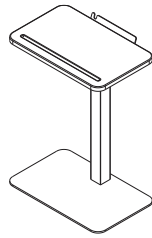

**Specify** **Notes**

- |  |   |
|--|---|
| <ul style="list-style-type: none"> <li>• Color Selection for Table Top- Shark Grey, Glacier White, or Cloud</li> <li>• Paint Selection for Leg and Base</li> </ul> | <ul style="list-style-type: none"> <li>• 3/4" thick top is available in three thermofoil finish options unique to AIS laptop tables.</li> <li>• Thermofoil top provides an edgeless surface, standard with PerformEx for built in scratch resistance.</li> <li>• Table is lightweight and mobile.</li> <li>• Laptop tables weigh 24 lbs.</li> <li>• 2" x 2" steel leg offers stability and durability and can be finished in all AIS paint options.</li> <li>• Standard with pencil groove and tech cradle to prop cell phones or tablets.</li> <li>• Standard with bag hook.</li> <li>• Weight capacity of laptop tables, up to 20 lbs.</li> </ul> |
|--|---|

**SIT TO STAND MOBILE DESK**

H	W	D	Model Number	List
42.9	26	20.5	T-FWS12-NT	660

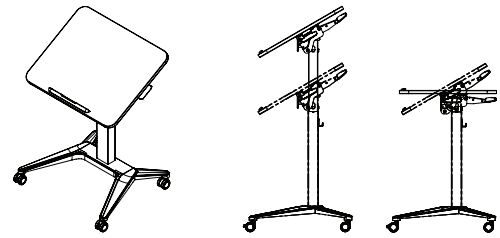

**Specify** **Notes**

- |  |
|--|
| <ul style="list-style-type: none"> <li>• Pneumatic tiltable and height adjustable mobile desk.</li> <li>• Worksurface size is 26"W x 20.5"D; thickness is .71".</li> <li>• Sit to stand mobile workstation weighs approximately 7 lbs.</li> <li>• Worksurface is white laminate with white 1mm edgeband.</li> <li>• Worksurface weight capacity is 17.6 pounds.</li> <li>• Base dimension is 25.6"W x 21.7"D.</li> <li>• Pneumatic height range is 29.9"-42.9" in the flat position.</li> <li>• Height adjustment is manual with squeeze lever.</li> <li>• Tilt adjustment with paddle lever. Tilt range is flat to 30 degrees.</li> <li>• Available in matte white with standard, two-toned gray and white locking casters.</li> <li>• Includes convenient bag hook, and integrated safety ledge stopper to keep documents and devices in place.</li> </ul> |
|--|



**National Showrooms:**

**Leominster**

AIS Headquarters  
25 Tucker Drive  
Leominster, MA 01453

---

**Chicago**

The Merchandise Mart  
Suite 391  
Chicago, Illinois 60654

**New York**

AIS New York  
257 Park Avenue South  
New York, New York 10010

**Washington, D.C.**

AIS Washington, D.C.  
1501 M St, NW, STE 230  
Washington, D.C. 20005

**GSA Sales**

GSA Contract 47QSMA20D08Q4  
Multiple Award Schedule (MAS)  
Large Category: Furniture & Furnishings  
Subcategories: Office Furniture, Packaged  
Office Furniture and Furniture Services

**For additional information on AIS:**

Dealer Showrooms, Representative  
Directory, Project Case Studies, Online  
Catalog & Product Showcase  
Visit: [www.ais-inc.com](http://www.ais-inc.com)