

OXYGEN™ BENCHING SYSTEM

January 2026 Price List

AIS

PRODUCT INFORMATION

Oxygen Statement of Line 4
 Oxygen Finish Options 8

PRODUCT DETAILS

Oxygen Product Details. 12
 Oxygen Electrical Components 18
 Oxygen Typical. 19

BENCH KITS

Powered Bench Kits with Access Boxes 22
 Chicago Junction Box Bench Kits with Access Boxes 23
 Powered Bench Kits with Grommets 24
 Chicago Junction Box Bench Kits with Grommets 25
 Non-Powered Bench Kits with Grommets 26

120 BENCH KITS

120 Powered Bench Kits with Access Boxes. 27
 120 Chicago Powered Bench Kits with Access Boxes 28
 120 Non-Powered Bench Kits with Access Boxes 29
 120 Powered Bench Kits with Grommets. 30
 120 Chicago Powered Bench Kits with Grommets 31
 120 Non-Powered Bench Kits with Grommets 32

RETURNS

Rectangular Returns 33
 Slant Returns 34
 Return Support Rails 35
 Return Strips 36

LEG KITS

Straight Leg Kits 37
 Slim Leg Kits 38
 Slant Leg Kits 39
 Stand-Alone Single Legs 40

END PANELS

Laminate End Panels 41

MODESTY PANELS

Full Modesty Panels for Rectangular Benches 43
 120 Modesty Panels and 120 Modesty Covers. 44

COVERS

End-of-Run Covers 45

GALLERY PANELS

Gallery Panels. 46

ELECTRICAL AND DATA

Duplex Outlets 49
 Data Plate Kits, Data Housing Units, and Single Gang Plate Adapter 51
 Jumpers and Infeeds 52
 Infeeds, Power Poles and Extenders 53

SPINE SCREENS

Glass 1/4" Universal Spine Insert Screens 56
 Glass 3/8" Universal Spine Insert Screens 57
 PET Universal Spine Insert Screens 58

STORAGE

Floor Bookcases 59
 Cabinet Door and Sliding Door Credenzas 60
 Shared Sliding Door Floor Bookcases 61
 Single Door Cabinets 62
 Mini Hutches and Mini Hutch Tackboards 63
 Mini Shared Shelves and Mini Shared Shelf Tackboards 64
 Single-Sided Desktop Bookcases 65
 Double-Sided Desktop Bookcases 66
 Spine Shared Desktop Bookcases 67
 Single-Sided and Spine Shared Desktop Bookcase Tackboards 68
 Endcap Hutches Endcap Hutch Tackboards 69
 Shared Overheads and Bench End Worksurfaces 69

PEDESTALS AND LATERAL FILES

Metal Freestanding Pedestals 71
 Freestanding Laminate Pedestals 72
 Freestanding Laminate Lateral Files 73

SLIM LEG TABLES

Pebble Tables with Slim Post Legs 74
 Corner Left Tables with Slim Post Legs 75
 Corner Right Tables with Slim Post Legs 76
 120° Corner and 60° Trapezoid with Slim Post Legs 77
 Round and Triangle Tables with Slim Post Legs 78

ACCESSORIES

Tool Rails and Bench End Worksurfaces 79
 Tool Bar Accessories and Spin-Out Pencil Drawers 80
 Credenza Cushions 81
 Lock Cores and Replacement Pulls 82
 Keyboard Arms and Accessories 83
 V-Series Keyboard Arms 84
 CPU Holders 85
 Power Data Solutions 86
 Power Data Solutions and Ganging Bolts 87

WARRANTY & TERMS AND CONDITIONS

For Warranty & Terms and Conditions please visit:
<https://www.ais-inc.com>

Note: Please see Screens Price Lists for Oxygen specific screens.

BENCH TOP KITS AND RETURNS

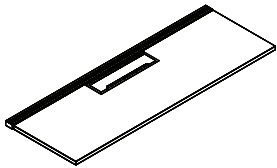

Single-Sided Bench Top Kits
Powered or Non-Powered

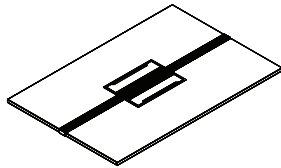

Double-Sided Bench Top Kits
Powered or Non-Powered

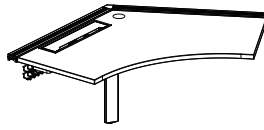

120 Single-Sided Bench Kit
Powered or Non-Powered
With Access Box or Grommet



120 Double-Sided Bench Kit
Powered or Non-Powered
With Access Box or Grommet

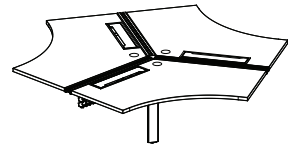

120 Triple-Sided Bench Kit
Powered or Non-Powered
With Access Box or Grommet

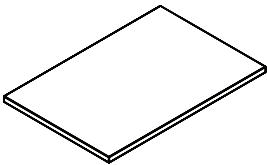

Rectangular Return Surfaces
With or Without Power Cut-Out

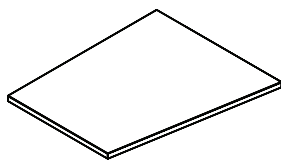

Slant Return Surfaces
With or Without Power Cut-Out

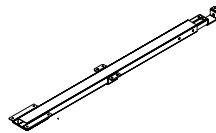

Return Support Rails

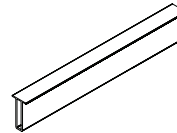

Return Strips

LEGS

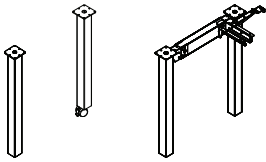

Straight Legs
Post Legs, End-of-Run, Shared and Mobile

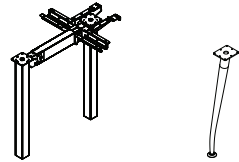

Slim Legs
Post Legs, End-of-Run, Shared and Mobile

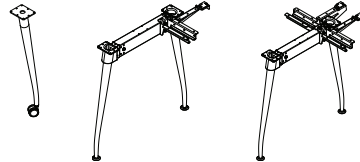

Slanted Legs
Post Legs, End-of-Run and Shared

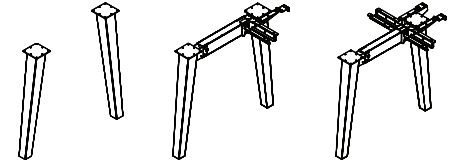

END PANELS

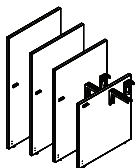

Single-Sided End Panel
Left or Right
Left Shown

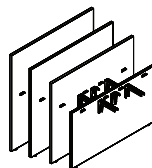

Double Sided End Panel

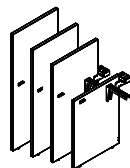

Mid-Run End Panel
Left or Right
Left Shown

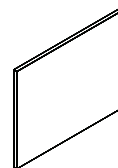

Modesty End Panel for
Rectangular Benches

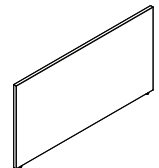

120 Modesty Panels
Single or Double, Full or Half

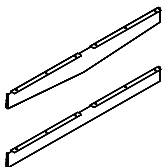

End-of-Run Covers
Flat or Tapered



120 Single Bench Modesty Cover
Full or Half

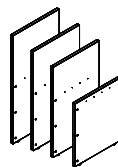

Gallery Panels

Note: Please see individual price list pages for specific sizes. Woodgrain on bench top runs parallel to spine beam. Woodgrain on end panels, modesty panels and gallery panels 18" wide to 60" wide runs vertically while panels 66" wide to 96" wide run horizontally. Bench top kits 36 and 42 accommodate (2) duplex outlets per seat, widths 48 - 96 accommodate (4) duplex outlets. Leg heights are 27.5 minimum with 1.5" glide range.

ELECTRICAL AND DATA

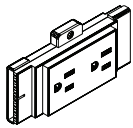

Duplex Outlet

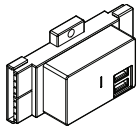

USB Outlet

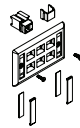

Data Plate Kit

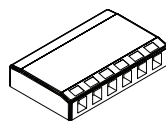

Surface Mount Data Housing Unit

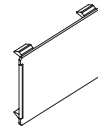

Duplex Outlet Cover

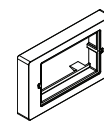

Single Gang Plate Adapter



Electrical Jumper



Ceiling Infeed

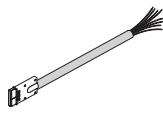

Side Mounted Base Infeed



Power/Data Pole Kit

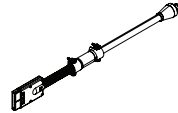

Single Circuit Side Infeed with Plug

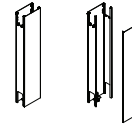

Side Mounted Based Infeed with Pole

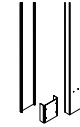

Power/Data Pole Extender



Expandable Cable Management Strip

STORAGE

26" High Storage

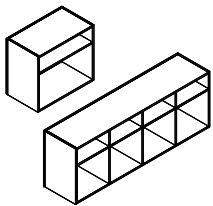

26" High Floor Bookcase

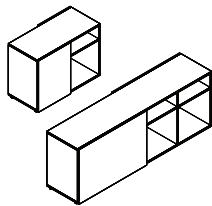

26" High Shared Floor Bookcase
Left or Right
Right Shown

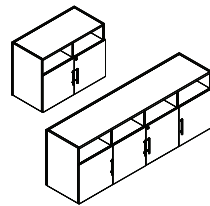

26" High Cabinet Door Credenza

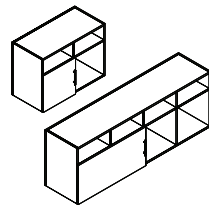

26" High Sliding Door Credenza

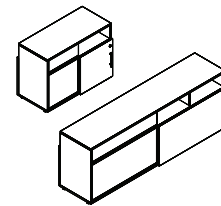

26" High Shared Sliding Door Floor Bookcase
Left or Right
Right Shown

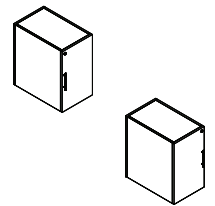

26" High Single Door Cabinet

Mini Hutches

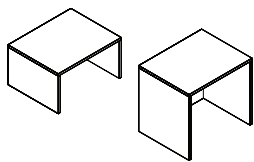

Single-Sided Mini Hutch

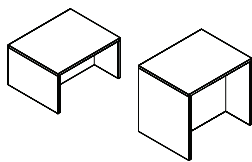

Double-Sided Mini Hutch

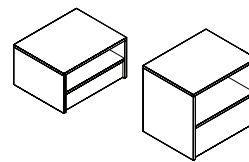

Horizontal Mini Shared Shelf

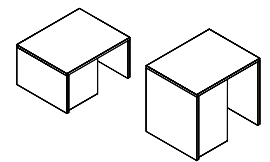

Vertical Mini Shared Shelf

Mini Shared Shelves

Desktop Bookcases

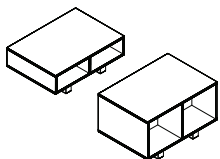

Single-Sided Bookcases

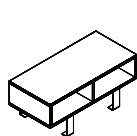

Single-Sided Bookcases on 8" Feet

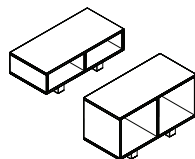

Double-Sided Bookcases

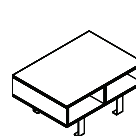

Double-Sided Bookcases on 8" Feet

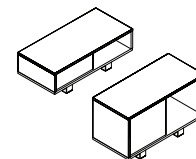

Spine Shared Bookcase

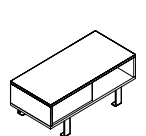

Spine Shared Bookcase on 8" Feet

STORAGE

Endcap Hutch

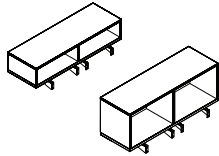

Endcap Hutch

Shared Overheads

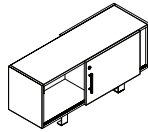

Shared Overheads with Sliding Doors

Bench End Worksurfaces

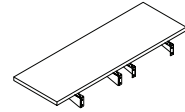

Bench End Worksurface

PEDESTALS AND LATERAL FILES

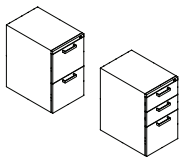

26" High Freestanding Pedestal
Box/Box/File or File/File

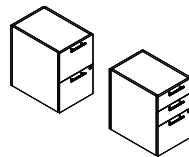

26" High Freestanding Pedestal
Box/Box/File or File/File

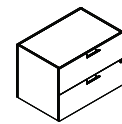

26" High Freestanding Lateral
File/File

SLIM LEG TABLES



Pebble Tables with Slim Post Legs
2mm or Knife Edge, On Glides or Casters
2mm Edge on Glides Shown

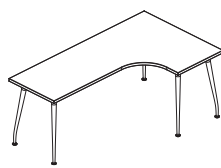

Corner Left Tables with Slim Post Legs
2mm or Knife Edge, On Glides or Casters
2mm Edge on Glides Shown

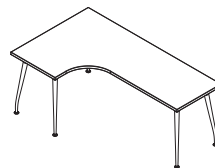

Corner Right Tables with Slim Post Legs
2mm or Knife Edge, On Glides or Casters
2mm Edge on Glides Shown

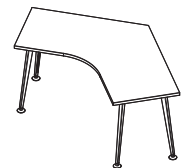

120° Corner Tables with Slim Post Legs
2mm or Knife Edge, On Glides or Casters
2mm Edge on Glides Shown



60° Trapezoid Tables with Slim Post Legs
2mm Edge, On Glides or Casters
2mm Edge on Glides Shown



Round Tables with Slim Post Legs
2mm or Knife Edge, On Glides or Casters
2mm Edge on Glides Shown



Triangle Tables with Slim Post Legs
2mm or Knife Edge, On Glides or Casters
2mm Edge on Glides Shown

ACCESSORIES

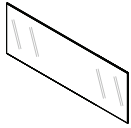

Universal Spine Insert Screens
Glass, Lexan or PET

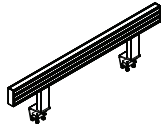

Rear-Mounted Tool Rail

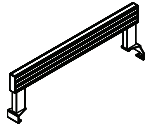

Front-To-Back Tool Bars
Left, Right or Shared

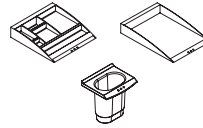

Standard Tool Bar Accessories

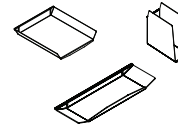

Metal Tool Bar Accessories

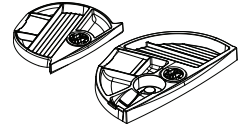

Spin-Out Pencil Drawers

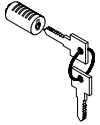

Lock Cores and Keys

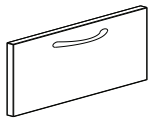

Replacement Pulls

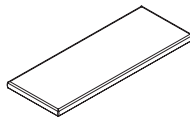

Credenza and Pedestal
Cushions

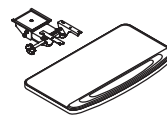

Keyboard Arms
Standard or Extended

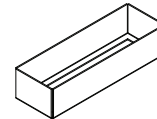

Oxygen Spacer

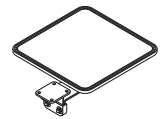

Standard Mouse Tray

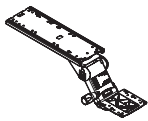

V-Series Keyboard Arms
Standard, Extended or Sit-Stand

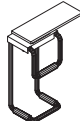

Ease Access CPU Holder

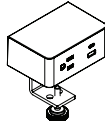

Power Data Solutions

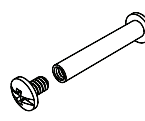

Ganging Bolt

Upholstery Fabric Options

UPHOLSTERY OPTIONS

Name	Grade
Durdle	A
Medley	A
Mirador	A
Palette	A
Terrain	A
Wellesley Polyurethane	A
Beehave	B
Gem	B
Stamper	B
Blazer	D

Performance Alta™

Frock	B
Mirage	B
Sway	B

CF Stinson Alliance Upholstery

Apprentice	B
Charlotte	D
Fleck	D
Lateral	D
Flanders	E
Hopsack	E
Outlander	E
Square One	E

Mayer Alliance Upholstery

Rumba	B
Fedora	C
Havana	C
Lancaster	C
Sydney	C
Channel	D
Engrave	D
Haven	D
Legacy	D
Utopia	E

Momentum Alliance Program

Bobby	B
Grid	B
Origen	B
Canter	C
Odyssey	C
Tradition	C
Boom II	D
Cover Cloth	D
Point	D
Beta	E
Faux Felt	E

Note: All AIS alta upholstery orders will have alta application as a standard feature. Alta enables virtually any textile to withstand the rigors of real life without leaving a mark. Alta improves repellency to oil and water based stains, is easy to clean and can enhance physical properties of the fibers. The technology is permanent and imperceptible to the eye and hand. To Clean: Blot with a dry towel. If residue remains, flush with warm water. Learn more at applied-textiles.com

C.O.M. Fabric Policy

- Please view all pre-approved COMs here:
<https://www.ais-inc.com/resources/fabrics-and-finishes/pre-approved-coms>
- It is mandatory that you work directly with your AIS Customer Service Representative for all COM related testing and orders. They will provide all necessary forms to you, as well as work with you with regard to sending in correct yardage and where to send it, along with necessary RA# or #s. Please note an RA must be submitted along with the fabric for testing, as well as an RA created for an actual order.
- Customer Service must be advised as to the width of the fabric rolls being supplied (54"W or 60"W). Customer Service must also be advised if the fabric has a backer.
- Yardage required for the job must be calculated by an AIS Customer Service Rep.
- Once AIS has approved the COM fabric, a fabric sample needs to be marked by the dealer with "Front", "Top", and "Bottom", to be sure fabric is applied correctly. The fabric sample then needs to be attached to a COM Fabric Dealer Form and forwarded to AIS Customer Service. [The COM Fabric Dealer Form may be downloaded or printed here.](#)
- Fabrics may be discontinued or obsolete without notice.
- Contact AIS Customer Service with any questions regarding fabric availability.
- All directional fabric will be railroaded.

VERTICAL SURFACE FABRICS

Name	Grade
Amaze	A
Avenue	A
Cape Cod	A
Engage	A
Mirador	A
New England	A
Rainfall	A
Simplicity	A
Theory	A
Twizzle	A
Lido	B
Marin	B
Nature	B
Off the Grid	B
Purpose	B
Spinel	B
Sprite	B

Note: 66" & 72" wide screens – if applying directional fabrics they will need to be railroaded for application. If using a COM fabric that is 54" wide, any screen over 48" wide would need to have the fabric railroaded as well.

C.O.M. Fabric Policy

- It is mandatory that you work directly with your AIS Customer Service Representative for all COM related testing and orders. They will provide all necessary forms to you, as well as work with you with regard to sending in correct yardage and where to send it, along with necessary RA# or #s. Please note an RA must be submitted along with the fabric for testing, as well as an RA created for an actual order.
- **Please Note:** A three to five yard sample is required for testing and approval for use on all monolithic panel systems. A one yard sample is required for testing and approval on Divi Insert Tiles, Matrix Tiles, flipper doors and tackboards. We may be able to test upholstery fabrics with a swatch, your Customer Service Representative will advise based on the fabric being tested; otherwise a 1 yard sample must be submitted for testing. Results take 48 - 72 hours.
- Customer Service must be advised as to the width of the fabric rolls being supplied (54"W or 60"W). Customer Service must also be advised if the fabric has a backer.
- Yardage required for the job must be calculated by an AIS Customer Service Rep.
- Once AIS has approved the COM fabric, a fabric sample needs to be marked by the dealer with "Front", "Top", and "Bottom", to be sure fabric is applied correctly. The fabric sample then needs to be attached to a COM Fabric Dealer Form and forwarded to AIS Customer Service. [The COM Fabric Dealer Form may be downloaded or printed here.](#)
- Fabrics may be discontinued or obsolete without notice.
- Contact AIS Customer Service with any questions regarding fabric availability.
- All directional fabric will be railroaded.

At AIS, we take great pride in offering a diverse selection of high-quality materials including but not limited to textiles, laminates, PET, mesh, etc. However, AIS cannot guarantee uniformity in dye lots across different production runs. As such, AIS is not liable for any variations in dye lots or color discrepancies in any of our products that may occur between orders. We encourage customers to review samples for color and texture matching prior to purchase. We are committed to providing exceptional products and are confident that our selection of textiles will meet your expectations for both aesthetic appeal and durability.

Paint, Edgeband, Tempered Glass and PET Options

OXYGEN PAINT OPTIONS

Name	Color Code	Grade
Black	BK	A
Chalk	CK	A
Dark Tone	DT	A
Grey Value 1	GV1	A
Innertone	HT	A
Light Tone	LT	A
Medium Tone	MT	A
Metallic Silver	MS	A
Satin White	SW	A
Warm Brown	WB	A
Champagne Metallic	CHM	B
Dark Grey Metallic	DGM	B
Flint Grey Metallic	FGM	B
Light Grey	LG	B
Tan Value 1	TV1	B
Antique Gold	AG	C
Graphite Sky	GS	C
Burnt Orange	BO	C
Brown	BR	C
Steel Blue	SB	C
Baltic Blue	BB	C
Ruby Red	RR	C
Kelly Green	KG	C

Custom Paints

Special Paint Match Process & Ordering Instructions

To initiate a special paint match, please provide **three physical match samples** to your Customer Service Representative (CSR). These samples will be sent to our paint suppliers for evaluation and matching.

Match Process & Fees:

- A **non-refundable \$450 net match fee** is required to begin the process.
- Once viable matches are developed (pending vendor capability), we'll send the samples to the dealer for final approval.

Pricing:

- Pricing begins at the **Grade C paint tier**.
- If the custom color incurs additional costs beyond Grade C pricing, we will advise of any upcharges before order placement.
- A **minimum order of \$100,000 List** is required for special paint orders.
- The **\$450 match fee will be waived** if the order is **\$150,000 List or more** (and placed using the approved color).

Ordering Instructions (after color approval):

1. Dealer submits the **Purchase Order (PO)** and **Bill of Materials (BOM)** for the product requiring special paint.
2. The PO must clearly state:
 - “**SPECIAL PAINT REQUIRED ON THIS ORDER**”
 - either in the header or special instructions section.
3. When selecting finishes:
 - Choose the **Grade C Paint option**.
 - **Do not select a final paint color**.
 - **Leave the paint code blank** and use the skip option.

PET COLOR OPTIONS

Name
Light Grey
Medium Grey
Navy
Olive Green
Warm Grey

EDGE BAND OPTIONS

Name	Color Code	Grade
Absolute Acajou	AA	A
Aimtoo Savatre	AS	A
Black	BK	A
Brazilwood	BZ	A
Chalk	CK	A
Corporate Walnut	CT	A
Dark Rum Cherry	DR	A
Dark Tone	DT	A
Field Elm	FE	A
Grand Cherry	GC	A
Grey Elm	GE	A
Grey Value 1	GV1	A
Landmark	LM	A
Leave Likatre	LV	A
Light Tone	LT	A
Linen	LN	A
Looks Likatre	LK	A
Maritime Dune	MD	A
Medium Tone	MT	A
Midwest Maple	MM	A
Neo Walnut	NW	A
Phantom Ecrú	PE	A
Phantom Pearl	PP	A
Satin White / True White	SW / TW	A
Storm	ST	A
Summer Drops	SD	A
Trytoo Savatre	TS	A
White Chocolate	WC	A

Custom Edgeband Options

- Custom match non-standard edgebands must be submitted as a special. Pricing varies based on edge thickness and finish.
- Minimum order size for any custom color is \$75,000.00 list. Extended lead-time will apply.

TEMPERED GLASS OPTIONS

Name	3/8" Thick Frameless Glass
Bronze Tint	Y
Clear	Y
Frosted	Y
Grey Tint	Y

All glass is tempered. The etched side of Frosted is only on one side of a screen, the opposite side is smooth. Please see specific price list pages on each type of glass for list pricing and upcharges.

Warranty:

All glass in AIS' product lines is tempered glass. By tempering the glass, the result is a stronger material that, if broken, fractures into smaller, less dangerous pieces. Tempered glass is commonly referred to as 'safety glass' due to this breakage feature. While the glass is stronger through tempering, it is critical to still handle with extreme care and caution and avoid impact that could result in damage. While uncommon, small impurities in the glass introduced during the tempering process, or damages to the edges resulting from handling or use, can cause unpredictable and spontaneous glass breakage, which is excluded from the AIS warranty.

Laminate Options

WORKSURFACE LAMINATE OPTIONS

Name	Grade
Absolute Acajou*	A
Aimtoo Savatre*	A
Black*	A
Brazilwood*	A
Chalk*	A
Corporate Walnut*	A
Dark Rum Cherry*	A
Field Elm	A
Grand Cherry*	A
Grey Elm	A
Landmark	A
Leave Likatre*	A
Linen	A
Looks Likatre*	A
Maritime Dune*	A
Midwest Maple*	A
Neo Walnut	A
Phantom Ecrú	A
Phantom Pearl	A
Storm*	A
Summer Drops*	A
True White*	A
Trytoo Savatre*	A
White Chocolate*	A
Asian Night	B
Asian Sand	B
Beige Granite	B
Colombian Walnut	B

WORKSURFACE LAMINATE OPTIONS

Name	Grade
Fonthill Pear	B
Grey Mesh	B
Gridlock in L.A.	B
Madagascar	B
Mahogany Clove	B
Monticello Maple	B
Nightfall	B
Paris White Potteryware	B
Pewter Mesh	B
Recon Oak	B
Shadow	B
Sunset	B
Titanium EV	B
Tungsten EV	B
White Spektrum	B
Windswept Poweter	B
Yorkshire Cherry	B
Ebony	C
Bright White (Writable Surface)	C
Pecan Woodline	C
Strand Burnt	C
Strand Wedge	C
Strand Wheat	C
Twill Earthen	C
Twill Graphite	C
Twill Sarum	C
Warm White	C

*Indicates a Grade A finish that can be used on Casegood body/case/door/drawer.

Oxygen Product Details

General Construction Details

- Worksurfaces are 1 1/8" thick, thermally fused laminate with matching edgeband. For available finishes please refer to Finishes section.
- High Pressure laminate options are available as a special, please note we are not able to offer matching edgebands for High Pressure laminates.
- Storage elements have 3/4" thick case construction with 1mm edge.
- Laminate drawer and door faces are 3/4" thick.
- 2mm edges available on worksurfaces and reverse knife edge on limited surfaces. See Product Detail: Edge Profile Details for examples.
- Leveling feet are adjustable up to 1" for all floor supported components.
- Units are finished all over, including the backs.
- Shelves will match body selection
- Laminate patterns such as grain or geometric shapes do not "match" face to face. However this is not noticeable on most laminate options with the exception of natural looking woods where cathedrals appear. AIS cannot guarantee that the woodgrain will match up on the different parts of the same surface.
- AIS recommends the use of mouse pads to protect longevity and integrity of worksurfaces.

Handle Options

- Five handle options are available:
 1. Bar Pull*
 2. Loop Pull*
 3. Rectangular Pull*
 4. L Pull*
 5. Slim Pull**
- All handles are available in any graded paint selection.
- The bar pull and rectangle pull are available in brushed nickel; the loop pull is available in bright metal. The slim and L Pull are only available with painted options.
- Laminate hinged doors may be configured with touch-to-open mechanism and no handles (not applicable to framed glass doors).
- Sliding doors include an option of no handle.
- Please see Product Detail: Drawer and Handles Guide for handle examples.

*Symbols default with the Bar Pull but can be adjusted while applying your finishes.
 The handle hole spread for Bar, Loop, Rectangular and L Pulls is 5" if you wish to supply your own handles.
 **The handle hole spread for the Slim Pull is specific to the drawer front size.

Storage

- AIS offers a wide variety of storage options and configurations that will work with your office needs. For more details please see below.
- Full depth units come with counterweights except for units with cut-outs.
- Partial depth units do not have counterweights. These units should be specified in a manner in which they are secured by a worksurface or ganged together with another storage unit using the Calibrate surface to support bracket.
- Framed doors are a silver vinyl wrapping with frosted acrylic.
- 18" deep towers and pull-out towers include a coat hook.
- 24" deep towers include a coat rod for hangers.
- Filing offered is side-to-side as standard for pencil lateral and file laterals that are 24" deep as well as partial depth laterals (22" deep and 29" deep).
- Front to back filing is an option that can be purchased as an accessory and will ship separately.
- All storage symbols will show the bar pull, however in worksheet you can swap the handle out as an option to one of the other standard offerings.
- 18" deep pedestals have 12" deep x 12" wide box drawers. Please see Product Detail: Pedestal and Lateral Dimensions for example.
- 24" deep pedestals have 20" deep x 12" wide box drawers. Please see Product Detail: Pedestal and Lateral Dimensions for example.
- 30" deep pedestals have 20" deep x 12" wide box drawers. Please see Product Detail: Pedestal and Lateral Dimensions for example.
- Pencil trays are included in the BBF and BF pedestals.
- Shelving counts: 42" high units have 2 shelves; 50" and 66" high units have 3 shelves; 74" and 82" high units have 4 shelves.
- Feet on storage are silver.

Overheads and Hutches

- Available as wall mounted or as a surface mounted hutch.
- Tackboards are specified separately, they do not come with the hutches.
- Installation details: Hutches will be secured to the top of the desk shell with cam and bolts or with double sided tape and screws to the wall and the side units when available. Hutch Wall Brackets (C-XHWB) are required when hutch is offset from wall or when not ganged to an adjacent tower unit.
- Wall mounted items are secured using cleat mounts. Security screws need to run through the wall cleat to assure that overhead cannot dislodge.

Locks

- Box/Box/Files (BBF) pedestals will only lock the file and the middle box drawer, not the top box.
- File/File (FF) pedestal locks will secure both drawers.
- For all lateral files, wardrobe and storage units the locks will secure the drawers/door for the entire unit.
- All drawers lock on 3, 4 and 5 drawer laterals.
- Units will come with 2 keys per lock.
- Key-alike options are available per storage unit, additional lock cores may be ordered (for an additional charge) to key-alike an entire office.
- Items with 2 or more locks per unit will be keyed alike.

Lock Guide

Five lock options are offered:

- A - No lock required
- B - Black Lock
- C - Silver Lock
- D - No lock w/ black T-ring for keyed-alike or Digital Lock*
- E - No lock w/ silver T-ring for keyed alike or Digital Lock*

Lock cores and trim rings do not ship installed.

*Keyed alike lock cores must be ordered separately.

Tackboards

- Tackboards are designed to work with your stations need, with or without storage.
- Tackboard fabric direction is vertical on 24" to 48" wide units and will run horizontally for 54" to 96" wide pieces.
- Please see Product Detail for examples of tackboard fabric direction.

Table Desks

- Table desks are offered with square or round corners and tapered legs only.
- Desk sizes range from 48" to 78" wide and 30" to 36" deep.
- If another leg option is needed, a standard top with one of the other post leg offerings can be specified.
- Table desks can be shared throughout the Calibrate line.

Oxygen Product Details

Drawer Handles Guide

Five handle options are available:

- Bar
- Rectangular
- Loop
- L Pull
- Slim Pull*

Door Handles Guide

Five handle options are available:

- Bar
- Rectangular
- Loop
- L Pull
- Touch to Open**
- No Handle***

*The Slim Pull option incurs an upcharge of \$75 list per unit.

**Available on laminate hinged doors only; not available on framed glass doors or sliding doors. Incurs an upcharge of \$50 per unit.

***Available on sliding doors.

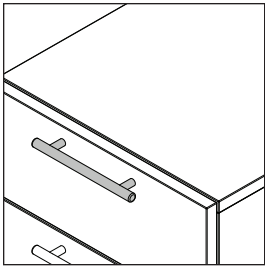

Bar

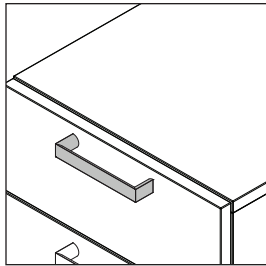

Rectangular

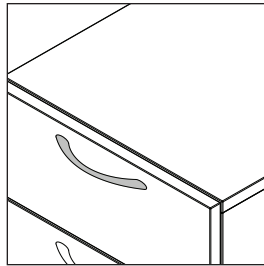

Loop

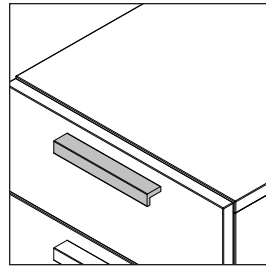

L Pull

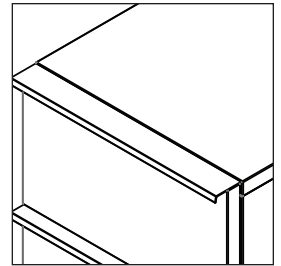

Slim Pull

Oxygen Product Details

**Product Detail 1
Bench Top Kit Dimensions**

Actual width on bench top kits is the same as the nominal width.

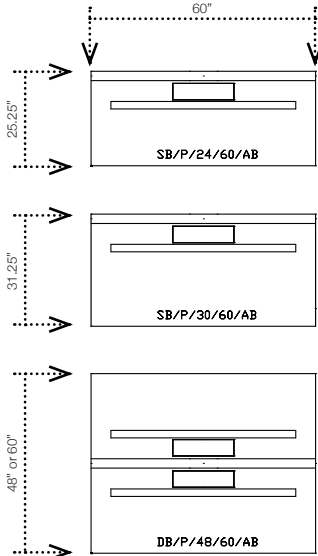

Actual depth on double-sided bench top kits is the same as nominal. Actual depth on single-sided kits is nominal plus 1.25", to allow for the spine beam.

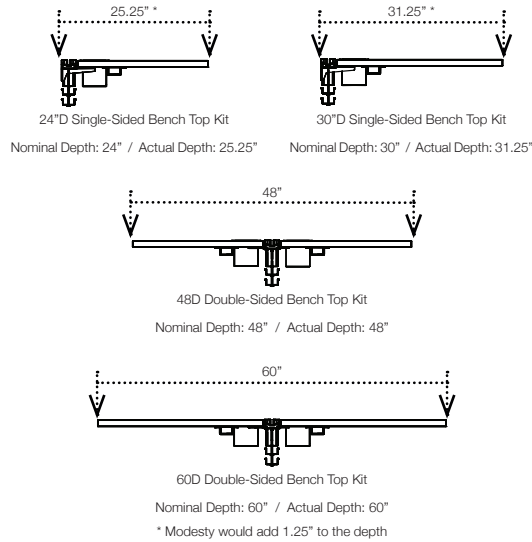

Spine beam allows for clamping accessories with a .25" space between the worksurface and spine beam.

Each of the 4 "basket" locations allow for .85" x .95" of cable space before overflowing.

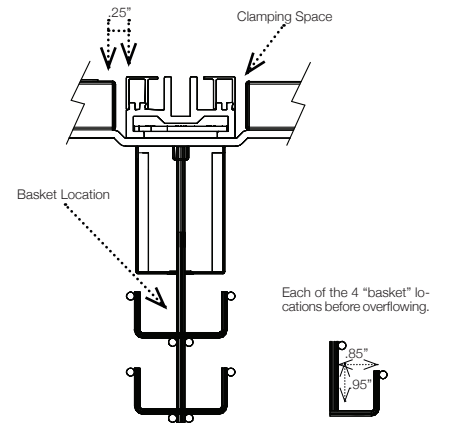

**Product Detail 2
Power and Data Details**

Power / Data Poles come in Double-Sided, Single-Sided and Base Infeed configurations. The single-sided poles are handed. Pole extenders are also available in 28" and 48" lengths.

Note: Widths 36 and 42 accommodate (2) duplex outlets per seat. Widths 48 - 96 accommodate (4) duplex outlets.

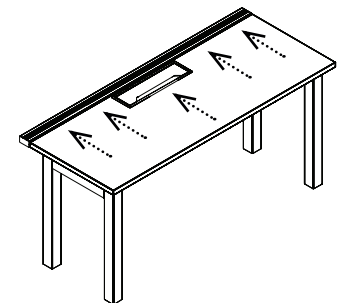
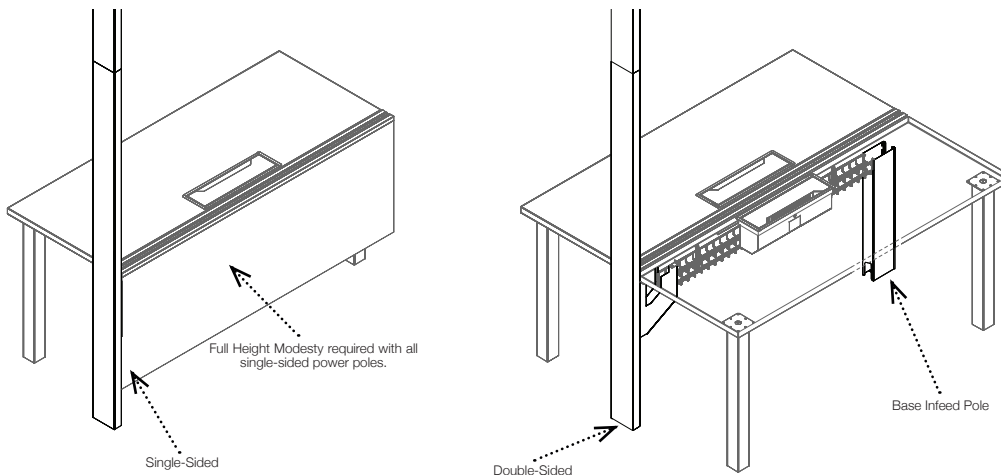

Monitor Arms and some accessories can clamp to rear of surface or inside the access box.

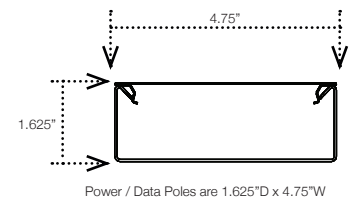

Oxygen Product Details

**Product Detail 3
Access Box and Storage Placement**

The access box location should be taken into consideration when placing 26" high storage elements. See below for examples and cautionary configurations. Note: where the access box can inhibit storage placement, the bench top kits with a grommet will not.

24"D x 48"W Single Bench

Access box will not allow for storage to be fully located under the bench surface.

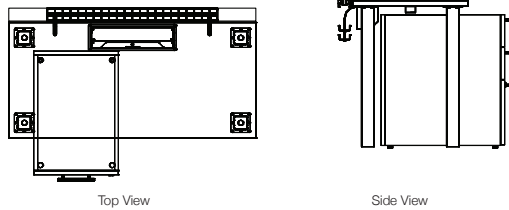

24"D x 60"W Single Bench

Access box will allow for storage to be located under the bench surface, however the wire trough will have the storage placed with a 1" overhang to the surface.

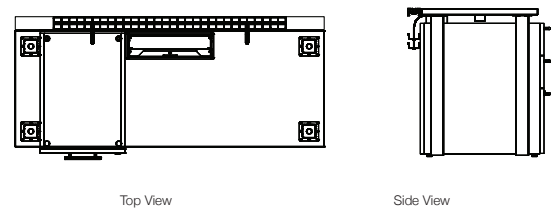

30"D x 48"W Single Bench

Access box will not allow for storage to be fully located under the bench surface.

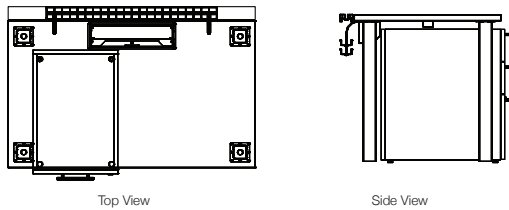

30"D x 60"W Single Bench

Access box will allow for storage to be fully located under the bench surface.

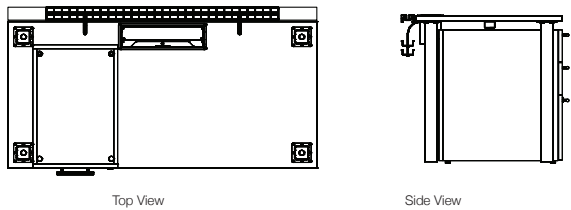

**Product Detail 4
Laminate End Panels and Creep**

Laminate End Panels will add 1.1" of creep for each end panel used.

Metal Legs = No Creep

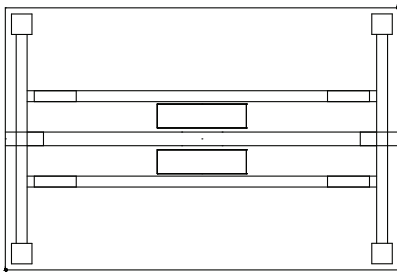

Laminate End Panels = 1.1" Creep each

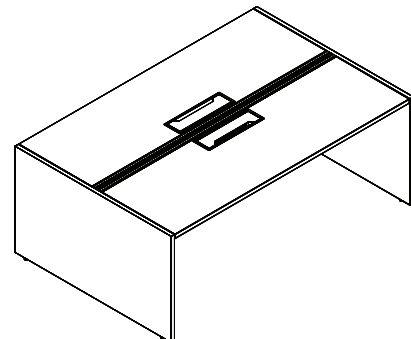
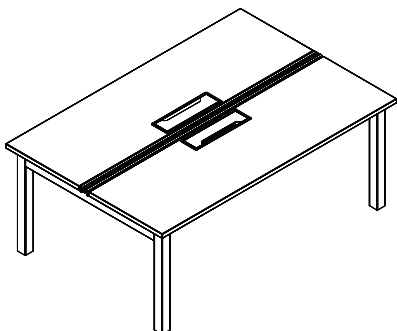
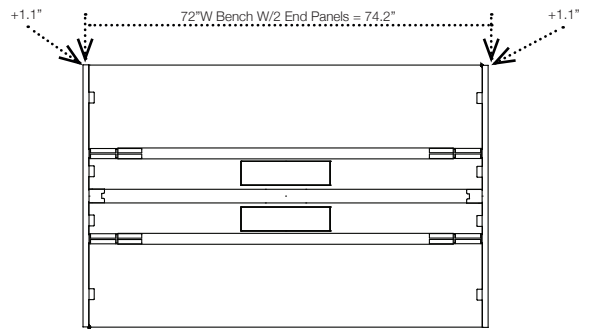

Oxygen Product Details

Grommet holes are 2 3/4" outside diameter with a 2 5/8" inside diameter (inside sleeve). Grommet covers are available in either grey or black and are included with the grommet options.

Important: Grommets are always 3.5" from the rear of the surface and 6" from the end of the surface.

Bench Top Kits with Access Box

Option A	No additional grommets	-
Option C	Location 1	+38
Option D	Location 2	+38
Option E	Location 1 + 2	+76

Notes: All bench top kits with access box automatically include the access box cut-out and box.

Note: Double-sided kits maintain left / right hand placement.

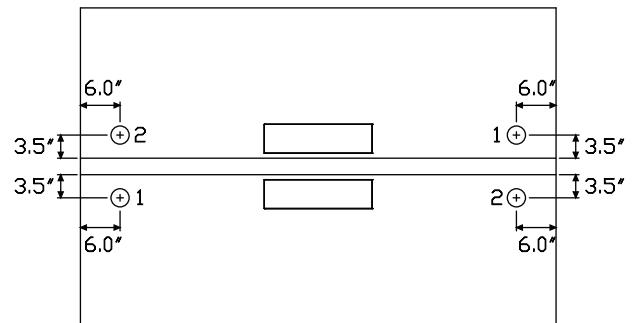
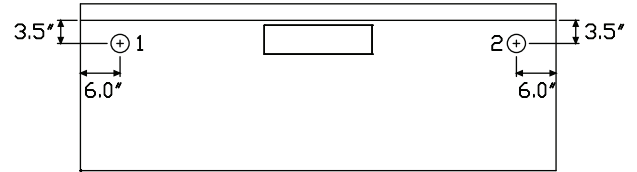

Bench Top Kits with Grommet

Option B	Center Only (Included)	-
Option C	Location 1 + Center	+38
Option D	Location 2 + Center	+38
Option E	Location 1 + 2 + Center	+76

Notes: All bench top kits with grommet automatically include the center grommet.

Note: Double-sided kits maintain left / right hand placement.

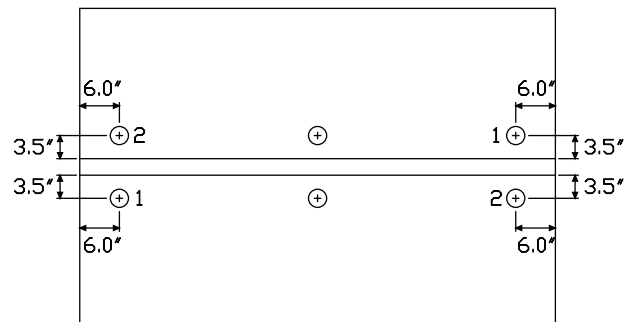
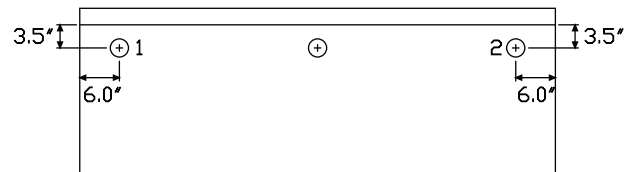

Oxygen Electrical Components

8 WIRE 4 CIRCUIT

AIS Oxygen 8 Wire 4 Circuit electrical system contains four circuits. Each circuit is rated at 20 amps/120 volts maximum. Circuit 1, Circuit 2 and Circuit 3 are served by a system neutral and an equipment ground. Circuit 4 is dedicated and is served by its own neutral and ground. Circuit and ground conductors are #12 A.G.W. (gauge). All neutrals are #10 A.G.W. (gauge).

Shown below is a cross section of metal cable used for 8 Wire 4 Circuit jumpers and infeeds. Circuit and ground conductors are #12 A.G.W. (gauge). All neutrals are #10 A.G.W. (gauge).

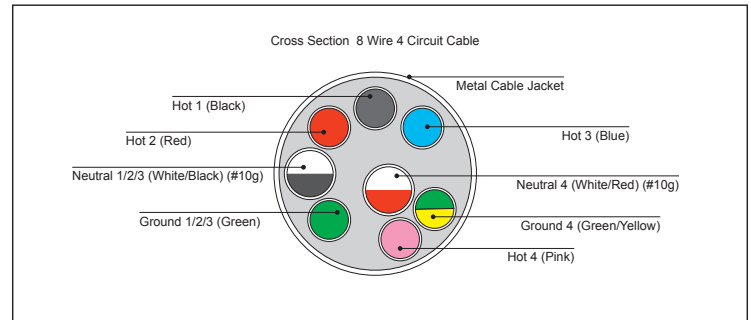
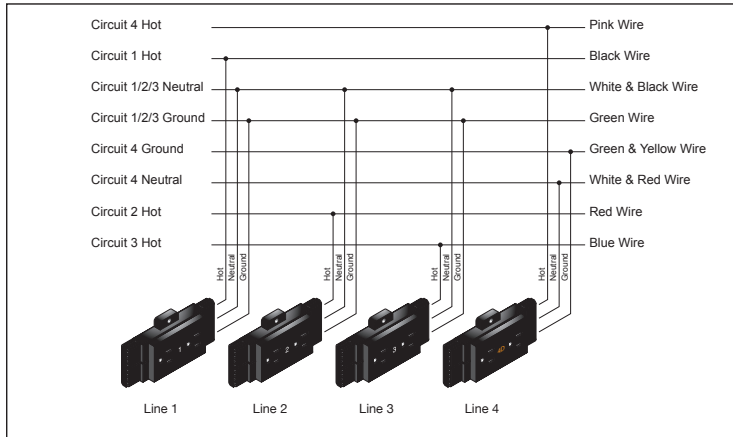

DUPLEX OUTLETS

Duplex Outlets are designated as circuits 1 through 4. Each duplex outlet contains two single receptacles (places to plug into) of the same circuit and are specified separately from powerways. All duplex outlets have black faces. The lettering on outlets for Circuit 1, 2 and 3 is white. The lettering on outlets for Circuit 4 is orange. Outlets are screw mounted to powerway. Duplex outlets are standard 15 amp outlets. For 20 amp outlets, call AIS Customer Service.

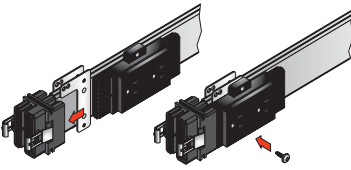

Common Equipment Amperages	
Personal Computer	2.00 - 4.00
Laser Printer	5.00 - 8.00
Desktop Plotter	1.50
Fan	1.00
Heater	8.50 - 12.50
Tasklight	1.00
Slide Projector	2.00 - 6.00
Fan	1.00
Coffee Pot	15.00
Paper Shredder	4.40 - 13.00
Radio	0.05
Pencil Sharpener	1.00
Calculator	0.25
Answering Machine	0.08

Typical 1

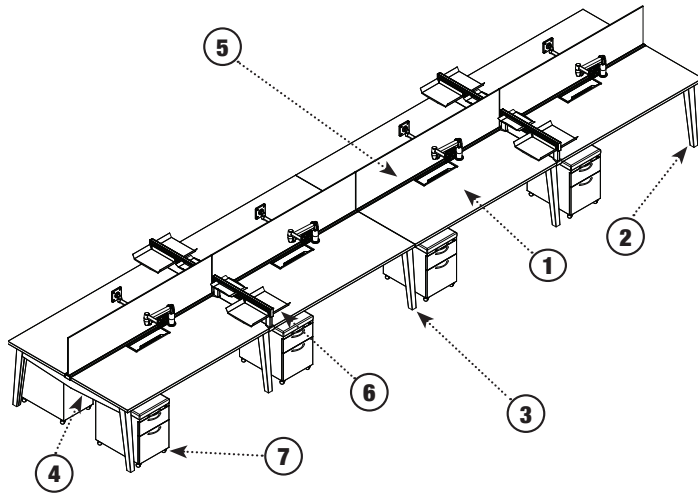

- 1. Double-Sided Powered Bench Kit w/ Access Box
- 2. Double-Sided Bench Slant Leg Kit
- 3. Double-Sided Bench Slant Leg Kit (Shared)
- 4. Slant Leg End-of-Run Cover (Tapered)
- 5. Glass Spine Screen
- 6. Front-to-Back Tool Bar
- 7. Mobile Box / File Pedestal w/ Cushion (see Calibrate Price List for Details)

Typical 2

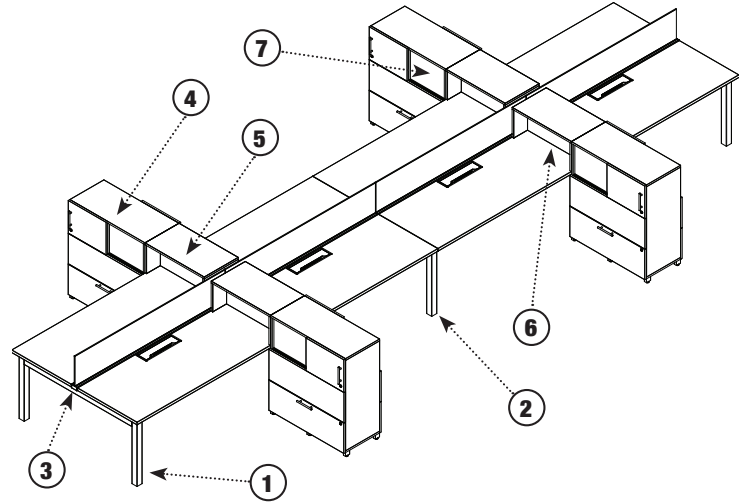

- 1. Double-Sided Bench Straight Leg Kit
- 2. Double-Sided Bench Straight Leg Kit (Shared)
- 3. Straight Leg End-of-Run Cover (Flat)
- 4. 42"H Shared Tower w/ Sliding Door (see Calibrate Price List for Details)
- 5. Shared Double-Sided Mini Hutch
- 6. Double-Sided Mini Hutch Tackboard
- 7. Glass Writing Surface

Typical 3

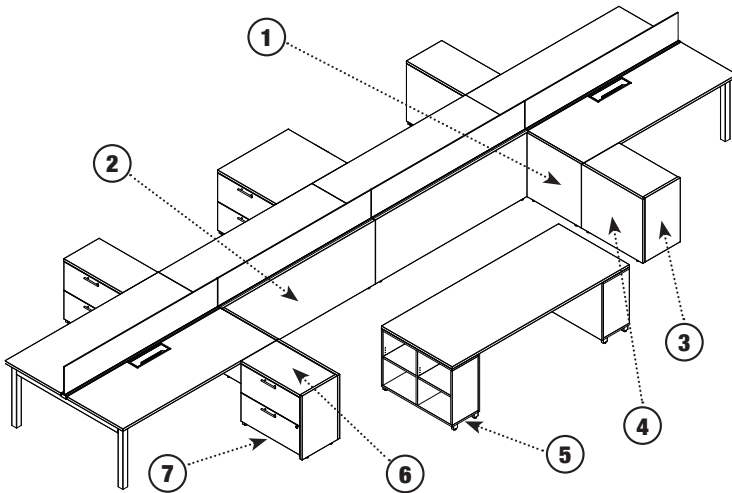

- 1. Mid-Run End Panel (Left)
- 2. Full Height Modesty Panel
- 3. Type B Gallery Panel (Female One End)
- 4. Type C Gallery Panel (Male Both Ends)
- 5. 27"H Laminate Floor Bookcase (see Calibrate Price List for Details)
- 6. 18" x 30" Standard Worksurface (see Worksurfaces Price List for Details)
- 7. 27"H Laminate Freestanding Lateral File (see Calibrate Price List for Details)

Typical 4

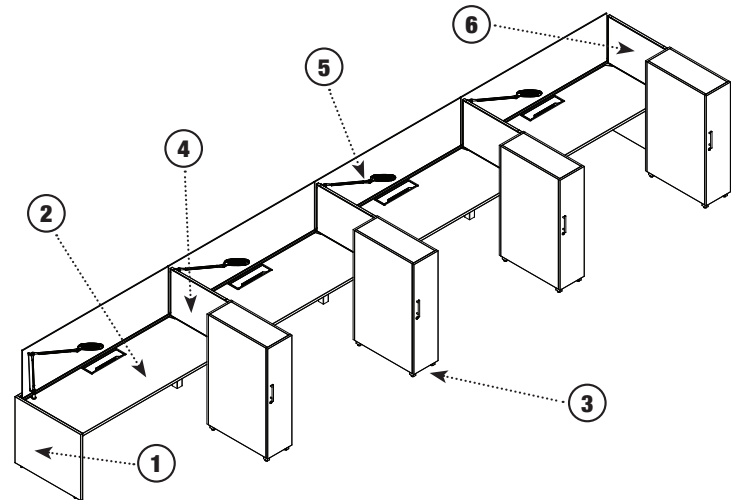

- 1. Single-Sided End Panel (Left)
- 2. Single-Sided Powered Bench Kit w/ Access Box
- 3. 50"H Single Door Cabinet (see Calibrate Price List for Details)
- 4. Shared Tackable Fabric / White Board Territory Screen
- 5. Clamp LED Task Light
- 6. Tackable Fabric / White Board Territory Screen

Typicals 5 - 8

Typical 5

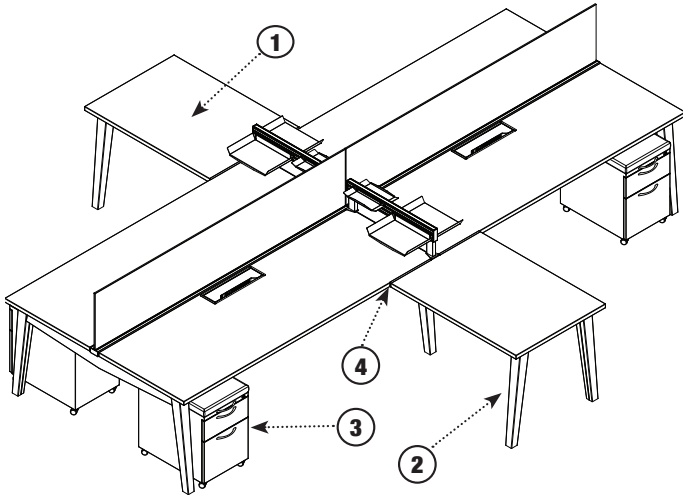

- 1. Rectangular Return Surface
- 2. Slant Stand-Alone Leg
- 3. Mobile Box / File Pedestal w/ Cushion
(see Calibrate Price List for Details)
- 4. Screen Clamp Return Strip (Center of Return)

Typical 6

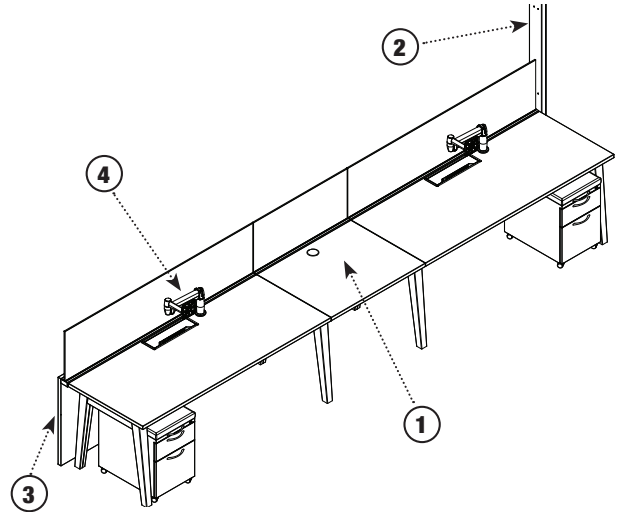

- 1. Single-Sided Powered Bench Kit w/ Grommet
- 2. Pole for Single-Sided Bench
- 3. Full Height Laminate Modesty Panel
- 4. Single Monitor Arm

Typical 7

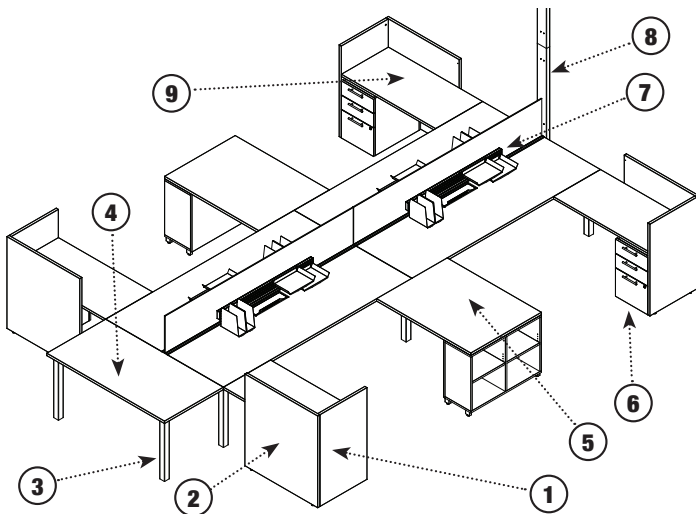

- 1. Type B Gallery Panel (Female One End)
- 2. Type C Gallery Panel (Male Both Ends)
- 3. Straight Stand-Alone Legs
- 4. 24" x 60" Worksurface
(see Worksurface Price List for Details)
- 5. 36" x 48" Rectangular Worksurface
(see Worksurface Price List for Details)
- 6. 26"H Laminate Box / Box / File Pedestal (Freestanding)
- 7. Worksurface Rear-Mounted Tool Rail
- 8. Pole for Double-Sided Bench
- 9. 24" x 48" Rectangular Return Surface

Typical 8

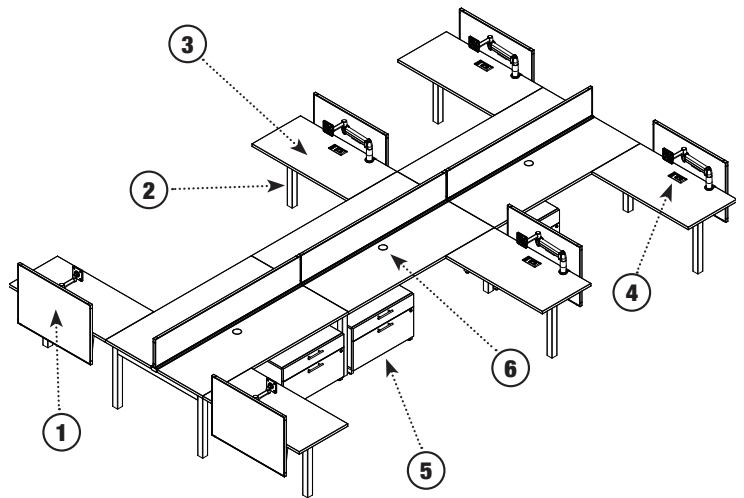

- 1. Tackable Fabric / White Board Side Mount Screen
- 2. Straight Stand-Alone Leg
- 3. Rectangular Return Surface w/ Power Cut-Out
- 4. Surface Access Desktop Power Module
- 5. 20"H Pencil Lateral File
- 6. Double-Sided Powered Bench Kit with Grommet

Typical 9

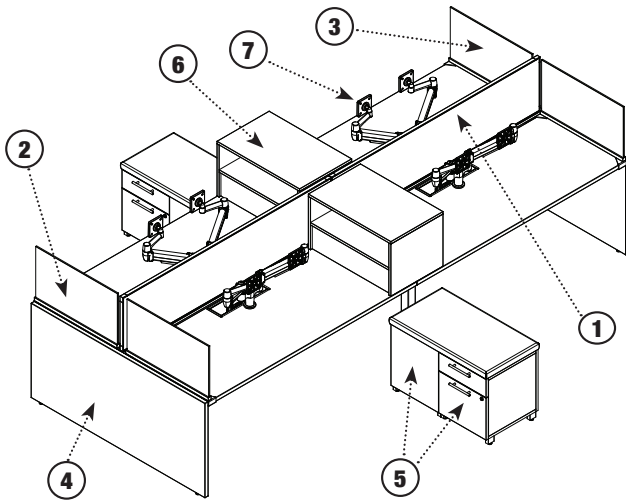

- 1. Tackable Fabric / White Board Spine Screen
- 2. Glass Territory Spine Screen (Right)
- 3. Glass Territory Spine Screen (Left)
- 4. Double-Sided End Panel
- 5. 20"H Laminate Box / File Pedestal (see Storage Price List for Details)
- 6. Horizontal Desktop Mini Shared Shelf
- 7. Double Monitor Arm

Typical 10

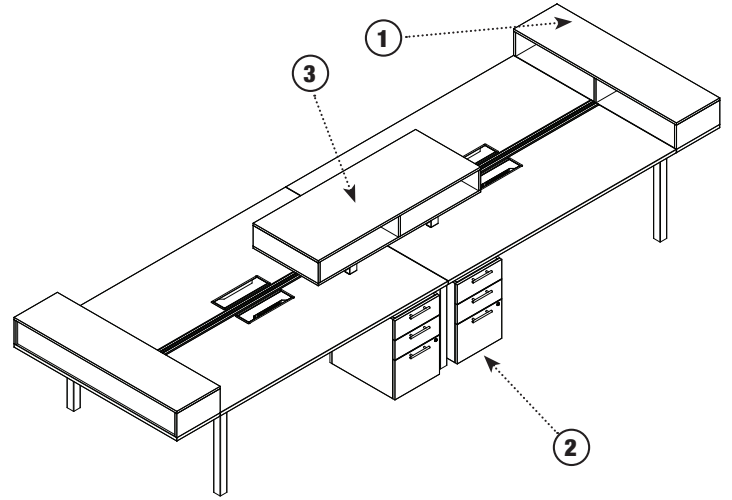

- 1. Endcap Hutch
- 2. 26"H Laminate Box / Box / File Pedestal
- 3. Double-Sided Desktop Bookcase on 4" Feet

Typical 11

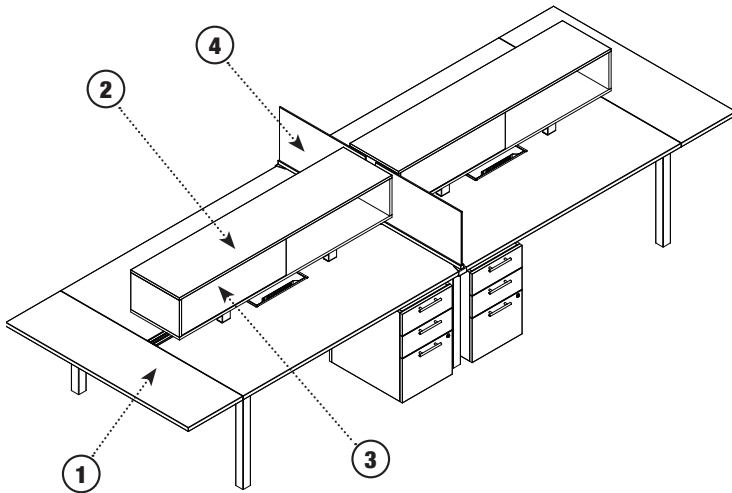

- 1. 18"D Bench End Worksurface
- 2. Spine Shared Desktop Bookcase Open on 4" Feet
- 3. Spine Shared Desktop Bookcase Open Tackboards
- 4. Shared Glass Territory Screen

Powered Bench Kits with Access Boxes

SINGLE-SIDED POWERED BENCH KIT WITH ACCESS BOX					
W	D	Model Number	List	Grade C Paint	Grade C Laminate
42	24	O-SBP2442	2,574	+10	+30
48	24	O-SBP2448	3,414	+10	+33
54	24	O-SBP2454	3,566	+10	+41
60	24	O-SBP2460	3,711	+10	+41
66	24	O-SBP2466	3,865	+10	+46
72	24	O-SBP2472	4,014	+10	+51
78	24	O-SBP2478	4,741	+10	+58
84	24	O-SBP2484	4,930	+10	+58
90	24	O-SBP2490	5,235	+10	+68
96	24	O-SBP2496	5,425	+10	+68
42	30	O-SBP3042	2,668	+10	+39
48	30	O-SBP3048	3,520	+10	+42
54	30	O-SBP3054	3,684	+10	+50
60	30	O-SBP3060	3,846	+10	+50
66	30	O-SBP3066	4,015	+10	+56
72	30	O-SBP3072	4,175	+10	+61
78	30	O-SBP3078	4,919	+10	+87
84	30	O-SBP3084	5,122	+10	+87
90	30	O-SBP3090	5,446	+10	+96
96	30	O-SBP3096	5,635	+10	+96

DOUBLE-SIDED POWERED BENCH KIT WITH ACCESS BOX					
W	D	Model Number	List	Grade C Paint	Grade C Laminate
42	48	O-DBP4842	3,334	+10	+30
48	48	O-DBP4848	4,248	+10	+33
54	48	O-DBP4854	4,477	+10	+41
60	48	O-DBP4860	4,697	+10	+41
66	48	O-DBP4866	4,925	+10	+46
72	48	O-DBP4872	5,148	+10	+51
78	48	O-DBP4878	6,428	+10	+58
84	48	O-DBP4884	6,708	+10	+58
90	48	O-DBP4890	6,973	+10	+68
96	48	O-DBP4896	7,235	+10	+68
42	60	O-DBP6042	3,525	+10	+39
48	60	O-DBP6048	4,466	+10	+42
54	60	O-DBP6054	4,723	+10	+50
60	60	O-DBP6060	4,971	+10	+50
66	60	O-DBP6066	5,227	+10	+56
72	60	O-DBP6072	5,472	+10	+61
78	60	O-DBP6078	6,777	+10	+87
84	60	O-DBP6084	7,089	+10	+87
90	60	O-DBP6090	7,379	+10	+96
96	60	O-DBP6096	7,671	+10	+96

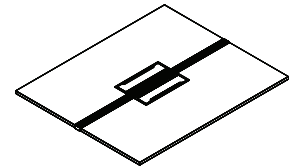
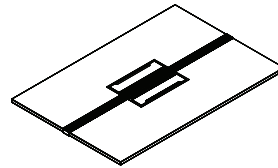
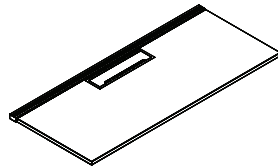
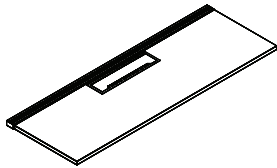

Specify

- Paint Selection for Spine Beam
- Paint Selection for Access Box
- Laminate Selection
- Edge Selection

Notes

- Bench Top Kits designed for use with any Oxygen leg type.
- Power is accessed through access box with flip door centered on the surface.
- Includes powerway, wire trough and spine beam for mounting screens.
- Order outlets and jumpers separately.
- Wood grain on bench tops runs parallel to spine beam.
- Width 42" accommodate (2) duplex outlets per seat. Widths 48" - 96" accommodate (4) duplex outlets.

Chicago Junction Box Bench Kits with Access Boxes

SINGLE-SIDED CHICAGO JUNCTION BOX BENCH KIT WITH ACCESS BOX

W	D	Model Number	List	Grade C Paint	Grade C Laminate
36	24	O-HSBP2436	2,408	+10	+28
42	24	O-HSBP2442	2,574	+10	+30
48	24	O-HSBP2448	3,414	+10	+33
54	24	O-HSBP2454	3,566	+10	+41
60	24	O-HSBP2460	3,711	+10	+41
66	24	O-HSBP2466	3,865	+10	+46
72	24	O-HSBP2472	4,014	+10	+51
78	24	O-HSBP2478	4,741	+10	+58
84	24	O-HSBP2484	4,930	+10	+58
90	24	O-HSBP2490	5,235	+10	+68
96	24	O-HSBP2496	5,425	+10	+68
36	30	O-HSBP3036	2,489	+10	+33
42	30	O-HSBP3042	2,668	+10	+39
48	30	O-HSBP3048	3,520	+10	+42
54	30	O-HSBP3054	3,684	+10	+50
60	30	O-HSBP3060	3,846	+10	+50
66	30	O-HSBP3066	4,015	+10	+56
72	30	O-HSBP3072	4,175	+10	+61
78	30	O-HSBP3078	4,919	+10	+87
84	30	O-HSBP3084	5,122	+10	+87
90	30	O-HSBP3090	5,446	+10	+96
96	30	O-HSBP3096	5,635	+10	+96

DOUBLE-SIDED CHICAGO JUNCTION BOX BENCH KIT WITH ACCESS BOX

W	D	Model Number	List	Grade C Paint	Grade C Laminate
36	48	O-HDBP4836	3,115	+10	+28
42	48	O-HDBP4842	3,334	+10	+30
48	48	O-HDBP4848	4,248	+10	+33
54	48	O-HDBP4854	4,477	+10	+41
60	48	O-HDBP4860	4,697	+10	+41
66	48	O-HDBP4866	4,925	+10	+46
72	48	O-HDBP4872	5,148	+10	+51
78	48	O-HDBP4878	6,428	+10	+58
84	48	O-HDBP4884	6,708	+10	+58
90	48	O-HDBP4890	6,973	+10	+68
96	48	O-HDBP4896	7,235	+10	+68
36	60	O-HDBP6036	3,278	+10	+33
42	60	O-HDBP6042	3,525	+10	+39
48	60	O-HDBP6048	4,466	+10	+42
54	60	O-HDBP6054	4,723	+10	+50
60	60	O-HDBP6060	4,971	+10	+50
66	60	O-HDBP6066	5,227	+10	+56
72	60	O-HDBP6072	5,472	+10	+61
78	60	O-HDBP6078	6,777	+10	+87
84	60	O-HDBP6084	7,089	+10	+87
90	60	O-HDBP6090	7,379	+10	+96
96	60	O-HDBP6096	7,671	+10	+96

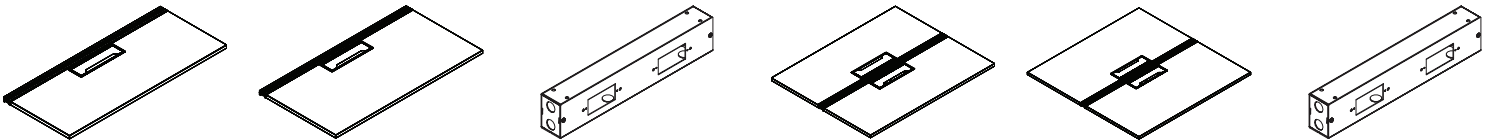

Specify

- Paint Selection for Spine Beam
- Paint Selection for Access Box
- Laminate Selection
- Edge Selection

Notes

- Bench Top Kits - Chicago Junction Box with Access Box are designed for use with any Oxygen leg type.
- Surface kits for 78" - 96" wide benches include a second crossbar for added structural support.
- Junction box allows for two single gang outlets per side.
- Junction boxes do not include electrical connectors.
- Boxes are UL listed.
- Boxes have standard 0.875" knockouts for electrical connectors.
- Junction boxes can be used with either 15 amp or 20 amp single gang outlets.
- Junction box is compatible with decorative outlets.

Powered Bench Kits with Grommets

SINGLE-SIDED POWERED BENCH KIT WITH GROMMET

W	D	Model Number	List	Grade C Paint	Grade C Laminate
36	24	O-SBG2436	2,034	+10	+28
42	24	O-SBG2442	2,200	+10	+30
48	24	O-SBG2448	3,036	+10	+33
54	24	O-SBG2454	3,189	+10	+41
60	24	O-SBG2460	3,336	+10	+41
66	24	O-SBG2466	3,491	+10	+46
72	24	O-SBG2472	3,638	+10	+51
78	24	O-SBG2478	4,366	+10	+58
84	24	O-SBG2484	4,554	+10	+58
90	24	O-SBG2490	4,851	+10	+68
96	24	O-SBG2496	5,041	+10	+68
36	30	O-SBG3036	2,117	+10	+33
42	30	O-SBG3042	2,294	+10	+39
48	30	O-SBG3048	3,145	+10	+42
54	30	O-SBG3054	3,310	+10	+50
60	30	O-SBG3060	3,468	+10	+50
66	30	O-SBG3066	3,640	+10	+56
72	30	O-SBG3072	3,801	+10	+61
78	30	O-SBG3078	4,542	+10	+87
84	30	O-SBG3084	4,745	+10	+87
90	30	O-SBG3090	5,069	+10	+96
96	30	O-SBG3096	5,259	+10	+96

DOUBLE-SIDED POWERED BENCH KIT WITH GROMMET

W	D	Model Number	List	Grade C Paint	Grade C Laminate
36	48	O-DBPG4836	2,465	+10	+28
42	48	O-DBPG4842	2,685	+10	+30
48	48	O-DBPG4848	3,600	+10	+33
54	48	O-DBPG4854	3,826	+10	+41
60	48	O-DBPG4860	4,048	+10	+41
66	48	O-DBPG4866	4,279	+10	+46
72	48	O-DBPG4872	4,502	+10	+51
78	48	O-DBPG4878	5,774	+10	+58
84	48	O-DBPG4884	6,058	+10	+58
90	48	O-DBPG4890	6,323	+10	+68
96	48	O-DBPG4896	6,586	+10	+68
36	60	O-DBPG6036	2,627	+10	+33
42	60	O-DBPG6042	2,872	+10	+39
48	60	O-DBPG6048	3,817	+10	+42
54	60	O-DBPG6054	4,071	+10	+50
60	60	O-DBPG6060	4,319	+10	+50
66	60	O-DBPG6066	4,575	+10	+56
72	60	O-DBPG6072	4,825	+10	+61
78	60	O-DBPG6078	6,128	+10	+87
84	60	O-DBPG6084	6,439	+10	+87
90	60	O-DBPG6090	6,730	+10	+96
96	60	O-DBPG6096	7,019	+10	+96

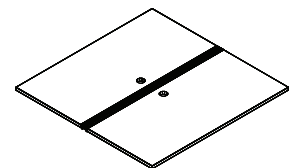
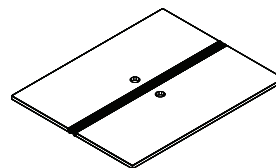
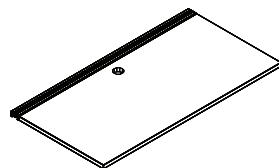
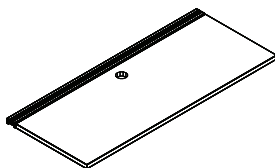

Specify

- Paint Selection for Spine Beam
- Grommet Color Selection
- Laminate Selection
- Edge Selection

Notes

- Bench Top Kits - Powered Grommet are designed for use with any Oxygen leg type.
- Power is accessed through a grommet centered on the surface.
- Includes powerway, wire trough and spine beam for mounting screens.
- Order outlets and jumpers separately.
- Wood grain on bench tops runs parallel to spine beam.
- Widths 36" and 42" accommodate (2) duplex outlets per seat. Widths 48" - 96" accommodate (4) duplex outlets.

Chicago Junction Box Bench Kits with Grommets

SINGLE-SIDED CHICAGO JUNCTION BOX BENCH KIT WITH GROMMET

W	D	Model Number	List	Grade C Paint	Grade C Laminate
36	24	O-HSBG2436	2,034	+10	+28
42	24	O-HSBG2442	2,200	+10	+30
48	24	O-HSBG2448	3,036	+10	+33
54	24	O-HSBG2454	3,189	+10	+41
60	24	O-HSBG2460	3,336	+10	+41
66	24	O-HSBG2466	3,491	+10	+46
72	24	O-HSBG2472	3,638	+10	+51
78	24	O-HSBG2478	4,366	+10	+58
84	24	O-HSBG2484	4,554	+10	+58
90	24	O-HSBG2490	4,851	+10	+68
96	24	O-HSBG2496	5,041	+10	+68
36	30	O-HSBG3036	2,117	+10	+33
42	30	O-HSBG3042	2,294	+10	+39
48	30	O-HSBG3048	3,145	+10	+42
54	30	O-HSBG3054	3,310	+10	+50
60	30	O-HSBG3060	3,468	+10	+50
66	30	O-HSBG3066	3,640	+10	+56
72	30	O-HSBG3072	3,801	+10	+61
78	30	O-HSBG3078	4,542	+10	+87
84	30	O-HSBG3084	4,745	+10	+87
90	30	O-HSBG3090	5,069	+10	+96
96	30	O-HSBG3096	5,259	+10	+96

DOUBLE-SIDED CHICAGO JUNCTION BOX BENCH KIT WITH GROMMET

W	D	Model Number	List	Grade C Paint	Grade C Laminate
36	48	O-HDBPG4836	2,465	+10	+28
42	48	O-HDBPG4842	2,685	+10	+30
48	48	O-HDBPG4848	3,600	+10	+33
54	48	O-HDBPG4854	3,826	+10	+41
60	48	O-HDBPG4860	4,048	+10	+41
66	48	O-HDBPG4866	4,279	+10	+46
72	48	O-HDBPG4872	4,502	+10	+51
78	48	O-HDBPG4878	5,774	+10	+58
84	48	O-HDBPG4884	6,058	+10	+58
90	48	O-HDBPG4890	6,323	+10	+68
96	48	O-HDBPG4896	6,586	+10	+68
36	60	O-HDBPG6036	2,627	+10	+33
42	60	O-HDBPG6042	2,872	+10	+39
48	60	O-HDBPG6048	3,817	+10	+42
54	60	O-HDBPG6054	4,071	+10	+50
60	60	O-HDBPG6060	4,319	+10	+50
66	60	O-HDBPG6066	4,575	+10	+56
72	60	O-HDBPG6072	4,825	+10	+61
78	60	O-HDBPG6078	6,128	+10	+87
84	60	O-HDBPG6084	6,439	+10	+87
90	60	O-HDBPG6090	6,730	+10	+96
96	60	O-HDBPG6096	7,019	+10	+96

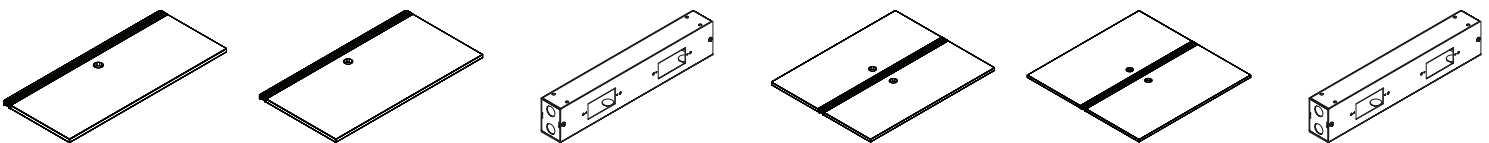

Specify

- Paint Selection for Spine Beam
- Grommet Color Selection
- Laminate Selection
- Edge Selection

Notes

- Bench Top Kits - Chicago Junction Box with Access Box are designed for use with any Oxygen leg type.
- Surface kits for 78" - 96" wide benches include a second crossbar for added structural support.
- Junction box allows for two single gang outlets per side.
- Junction boxes do not include electrical connectors.
- Boxes are UL listed.
- Boxes have standard 0.875" knockouts for electrical connectors.
- Junction boxes can be used with either 15 amp or 20 amp single gang outlets.
- Junction box is compatible with decorative outlets.

Non-Powered Bench Kits with Grommets

SINGLE-SIDED NON-POWERED BENCH KIT WITH GROMMET

W	D	Model Number	List	Grade C Paint	Grade C Laminate
36	24	O-SBN2436	1,494	+10	+28
42	24	O-SBN2442	1,658	+10	+30
48	24	O-SBN2448	2,497	+10	+33
54	24	O-SBN2454	2,651	+10	+41
60	24	O-SBN2460	2,796	+10	+41
66	24	O-SBN2466	2,952	+10	+46
72	24	O-SBN2472	3,094	+10	+51
78	24	O-SBN2478	3,825	+10	+58
84	24	O-SBN2484	4,018	+10	+58
90	24	O-SBN2490	4,326	+10	+68
96	24	O-SBN2496	4,505	+10	+68
36	30	O-SBN3036	1,575	+10	+33
42	30	O-SBN3042	1,754	+10	+39
48	30	O-SBN3048	2,603	+10	+42
54	30	O-SBN3054	2,771	+10	+50
60	30	O-SBN3060	2,928	+10	+50
66	30	O-SBN3066	3,100	+10	+56
72	30	O-SBN3072	3,260	+10	+61
78	30	O-SBN3078	4,002	+10	+87
84	30	O-SBN3084	4,205	+10	+87
90	30	O-SBN3090	4,530	+10	+96
96	30	O-SBN3096	4,723	+10	+96

DOUBLE-SIDED NON-POWERED BENCH KIT WITH GROMMET

W	D	Model Number	List	Grade C Paint	Grade C Laminate
36	48	O-DBNG4836	1,977	+10	+28
42	48	O-DBNG4842	2,198	+10	+30
48	48	O-DBNG4848	3,115	+10	+33
54	48	O-DBNG4854	3,344	+10	+41
60	48	O-DBNG4860	3,566	+10	+41
66	48	O-DBNG4866	3,791	+10	+46
72	48	O-DBNG4872	4,015	+10	+51
78	48	O-DBNG4878	5,291	+10	+58
84	48	O-DBNG4884	5,575	+10	+58
90	48	O-DBNG4890	5,980	+10	+68
96	48	O-DBNG4896	6,248	+10	+68
36	60	O-DBNG6036	2,140	+10	+33
42	60	O-DBNG6042	2,388	+10	+39
48	60	O-DBNG6048	3,333	+10	+42
54	60	O-DBNG6054	3,585	+10	+50
60	60	O-DBNG6060	3,836	+10	+50
66	60	O-DBNG6066	4,089	+10	+56
72	60	O-DBNG6072	4,338	+10	+61
78	60	O-DBNG6078	5,642	+10	+87
84	60	O-DBNG6084	5,953	+10	+87
90	60	O-DBNG6090	6,244	+10	+96
96	60	O-DBNG6096	6,532	+10	+96

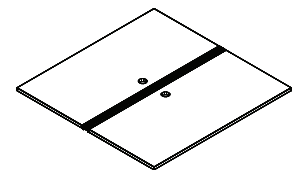
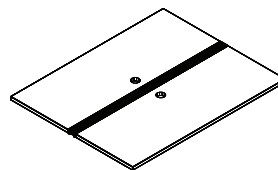
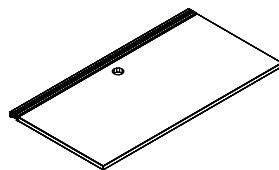
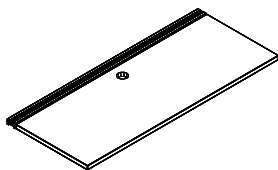

Specify

- Paint Selection for Spine Beam
- Grommet Color Selection
- Laminate Selection
- Edge Selection

Notes

- Bench Top Kits - Non-Powered with Grommet are designed for use with any Oxygen leg type.
- Includes wire trough and spine beam only for mounting screens (no powerway).
- Wood grain on bench tops runs parallel to spine beam.
- Widths 36" and 42" accommodate (2) duplex outlets per seat. Widths 48" - 96" accommodate (4) duplex outlets.

120 Powered Bench Kits with Access Boxes

120 SINGLE-SIDED POWERED BENCH KIT WITH ACCESS BOX

W	D	Left	Right	List	Grade C Paint	Grade C Laminate
		Model Number	Model Number			
36	24	O-120SBPL2436	O-120SBPR2436	4,813	+20	+47
42	24	O-120SBPL2442	O-120SBPR2442	5,128	+20	+58
48	24	O-120SBPL2448	O-120SBPR2448	5,959	+20	+64
54	24	O-120SBPL2454	O-120SBPR2454	6,274	+20	+76
60	24	O-120SBPL2460	O-120SBPR2460	6,590	+20	+82
36	30	O-120SBPL3036	O-120SBPR3036	4,974	+20	+64
42	30	O-120SBPL3042	O-120SBPR3042	5,288	+20	+76
48	30	O-120SBPL3048	O-120SBPR3048	6,123	+20	+82
54	30	O-120SBPL3054	O-120SBPR3054	6,435	+20	+95
60	30	O-120SBPL3060	O-120SBPR3060	6,752	+20	+103

120 DOUBLE-SIDED POWERED BENCH KIT WITH ACCESS BOX

W	D	Left	Right	List	Grade C Paint	Grade C Laminate
		Model Number	Model Number			
36	24	O-120DBPL2436	O-120DBPR2436	7,660	+20	+94
42	24	O-120DBPL2442	O-120DBPR2442	8,191	+20	+116
48	24	O-120DBPL2448	O-120DBPR2448	9,499	+20	+128
54	24	O-120DBPL2454	O-120DBPR2454	10,033	+20	+152
60	24	O-120DBPL2460	O-120DBPR2460	10,565	+20	+164
36	30	O-120DBPL3036	O-120DBPR3036	7,982	+20	+128
42	30	O-120DBPL3042	O-120DBPR3042	8,515	+20	+152
48	30	O-120DBPL3048	O-120DBPR3048	9,822	+20	+164
54	30	O-120DBPL3054	O-120DBPR3054	10,356	+20	+190
60	30	O-120DBPL3060	O-120DBPR3060	10,889	+20	+206

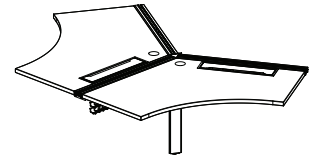
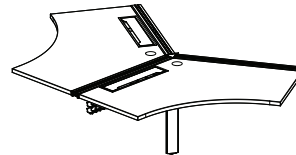
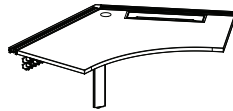
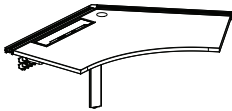

120 TRIPLE-SIDED POWERED BENCH KIT WITH ACCESS BOX

W	D	Left	Right	List	Grade C Paint	Grade C Laminate
		Model Number	Model Number			
36	24	O-120TBPL2436	O-120TBPR2436	9,147	+20	+141
42	24	O-120TBPL2442	O-120TBPR2442	9,803	+20	+174
48	24	O-120TBPL2448	O-120TBPR2448	11,231	+20	+192
54	24	O-120TBPL2454	O-120TBPR2454	11,885	+20	+228
60	24	O-120TBPL2460	O-120TBPR2460	12,540	+20	+246
36	30	O-120TBPL3036	O-120TBPR3036	9,633	+20	+192
42	30	O-120TBPL3042	O-120TBPR3042	10,287	+20	+228
48	30	O-120TBPL3048	O-120TBPR3048	11,716	+20	+246
54	30	O-120TBPL3054	O-120TBPR3054	12,371	+20	+285
60	30	O-120TBPL3060	O-120TBPR3060	13,023	+20	+309

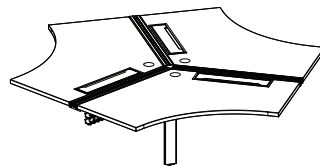
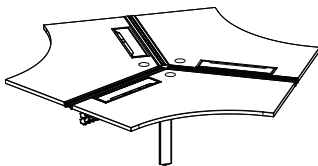

Specify

- Paint Selection for Spine Beam
- Paint Selection for Access Box
- Laminate Selection
- Edge Selection

Notes

- 120 Bench Top Kits - Powered with Access Box are designed for use with any Oxygen leg type.
- Center leg is included.
- Power is accessed through access box with flip door centered on the surface.
- Includes powerway, wire trough and spine beam for mounting screens.
- Order outlets and jumpers separately. Wood grain on bench tops runs parallel to spine beam.
- Width 36" and 42" accommodate (4) duplex outlets per seat. Widths 48" - 60" accommodate (8) duplex outlets.
- Access Boxes provide access to only 4 outlets.

120 Chicago Powered Bench Kits with Access Boxes

120 SINGLE-SIDED CHICAGO POWERED BENCH KIT WITH ACCESS BOX

W	D	Left	Right	List	Grade C Paint	Grade C Laminate
		Model Number	Model Number			
36	24	O-120HSBPL2436	O-120HSBPR2436	4,813	+20	+47
42	24	O-120HSBPL2442	O-120HSBPR2442	5,128	+20	+58
48	24	O-120HSBPL2448	O-120HSBPR2448	5,959	+20	+64
54	24	O-120HSBPL2454	O-120HSBPR2454	6,274	+20	+76
60	24	O-120HSBPL2460	O-120HSBPR2460	6,590	+20	+82
36	30	O-120HSBPL3036	O-120HSBPR3036	4,974	+20	+64
42	30	O-120HSBPL3042	O-120HSBPR3042	5,288	+20	+76
48	30	O-120HSBPL3048	O-120HSBPR3048	6,123	+20	+82
54	30	O-120HSBPL3054	O-120HSBPR3054	6,435	+20	+95
60	30	O-120HSBPL3060	O-120HSBPR3060	6,752	+20	+103

120 DOUBLE-SIDED CHICAGO POWERED BENCH KIT WITH ACCESS BOX

W	D	Left	Right	List	Grade C Paint	Grade C Laminate
		Model Number	Model Number			
36	24	O-120HDBPL2436	O-120HDBPR2436	7,660	+20	+94
42	24	O-120HDBPL2442	O-120HDBPR2442	8,191	+20	+116
48	24	O-120HDBPL2448	O-120HDBPR2448	9,499	+20	+128
54	24	O-120HDBPL2454	O-120HDBPR2454	10,033	+20	+152
60	24	O-120HDBPL2460	O-120HDBPR2460	10,565	+20	+164
36	30	O-120HDBPL3036	O-120HDBPR3036	7,982	+20	+128
42	30	O-120HDBPL3042	O-120HDBPR3042	8,515	+20	+152
48	30	O-120HDBPL3048	O-120HDBPR3048	9,822	+20	+164
54	30	O-120HDBPL3054	O-120HDBPR3054	10,356	+20	+190
60	30	O-120HDBPL3060	O-120HDBPR3060	10,889	+20	+206

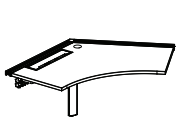

Left



Right

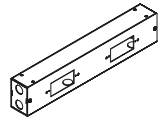

Hardwire Junction Box

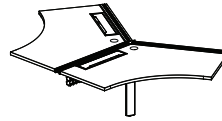

Left

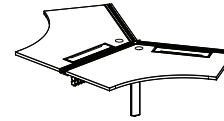

Right

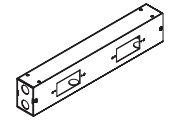

Hardwire Junction Box

120 TRIPLE-SIDED CHICAGO POWERED BENCH KIT WITH ACCESS BOX

W	D	Left	Right	List	Grade C Paint	Grade C Laminate
		Model Number	Model Number			
36	24	O-120HTBPL2436	O-120HTBPR2436	9,147	+20	+141
42	24	O-120HTBPL2442	O-120HTBPR2442	9,803	+20	+174
48	24	O-120HTBPL2448	O-120HTBPR2448	11,231	+20	+192
54	24	O-120HTBPL2454	O-120HTBPR2454	11,885	+20	+228
60	24	O-120HTBPL2460	O-120HTBPR2460	12,540	+20	+246
36	30	O-120HTBPL3036	O-120HTBPR3036	9,633	+20	+192
42	30	O-120HTBPL3042	O-120HTBPR3042	10,287	+20	+228
48	30	O-120HTBPL3048	O-120HTBPR3048	11,716	+20	+246
54	30	O-120HTBPL3054	O-120HTBPR3054	12,371	+20	+285
60	30	O-120HTBPL3060	O-120HTBPR3060	13,023	+20	+309

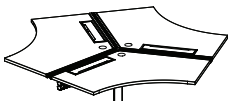

Left

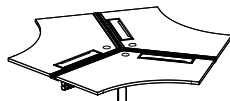

Right

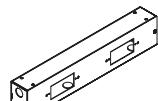

Hardwire Junction Box

Specify

- Paint Selection for Spine Beam
- Paint Selection for Access Box
- Laminate Selection
- Edge Selection

Notes

- 120 Bench Top Kits - Powered with Access Box are designed for use with any Oxygen leg type.
- Center leg is included.
- Power is accessed through access box with flip door centered on the surface.
- Includes powerway, wire trough and spine beam for mounting screens. Order outlets and jumpers separately.
- Wood grain on bench tops runs parallel to spine beam.
- Width 36" and 42" accommodate (4) duplex outlets per seat. Widths 48" - 60" accommodate (8) duplex outlets.
- Access Boxes provide access to only 4 outlets.

120 Non-Powered Bench Kits with Access Boxes

120 SINGLE-SIDED NON-POWERED BENCH KIT WITH ACCESS BOX

W	D	Left	Right	List	Grade C Paint	Grade C Laminate
		Model Number	Model Number			
36	24	O-120SBNL2436	O-120SBNR2436	3,358	+20	+47
42	24	O-120SBNL2442	O-120SBNR2442	3,676	+20	+58
48	24	O-120SBNL2448	O-120SBNR2448	3,989	+20	+64
54	24	O-120SBNL2454	O-120SBNR2454	4,304	+20	+76
60	24	O-120SBNL2460	O-120SBNR2460	4,620	+20	+82
36	30	O-120SBNL3036	O-120SBNR3036	3,521	+20	+64
42	30	O-120SBNL3042	O-120SBNR3042	3,837	+20	+76
48	30	O-120SBNL3048	O-120SBNR3048	4,150	+20	+82
54	30	O-120SBNL3054	O-120SBNR3054	4,465	+20	+95
60	30	O-120SBNL3060	O-120SBNR3060	4,779	+20	+103

120 DOUBLE-SIDED NON-POWERED BENCH KIT WITH ACCESS BOX

W	D	Left	Right	List	Grade C Paint	Grade C Laminate
		Model Number	Model Number			
36	24	O-120DBNL2436	O-120DBNR2436	5,494	+20	+94
42	24	O-120DBNL2442	O-120DBNR2442	6,027	+20	+116
48	24	O-120DBNL2448	O-120DBNR2448	7,079	+20	+128
54	24	O-120DBNL2454	O-120DBNR2454	7,612	+20	+152
60	24	O-120DBNL2460	O-120DBNR2460	8,142	+20	+164
36	30	O-120DBNL3036	O-120DBNR3036	5,817	+20	+128
42	30	O-120DBNL3042	O-120DBNR3042	6,351	+20	+152
48	30	O-120DBNL3048	O-120DBNR3048	7,402	+20	+164
54	30	O-120DBNL3054	O-120DBNR3054	7,933	+20	+190
60	30	O-120DBNL3060	O-120DBNR3060	8,467	+20	+206

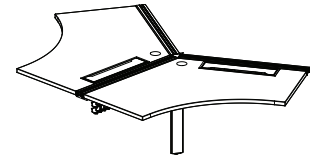
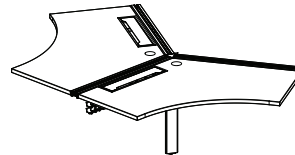
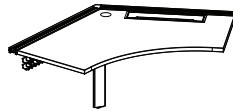
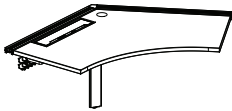

120 TRIPLE-SIDED NON-POWERED BENCH KIT WITH ACCESS BOX

W	D	Left	Right	List	Grade C Paint	Grade C Laminate
		Model Number	Model Number			
36	24	O-120TBNL2436	O-120TBNR2436	6,984	+20	+141
42	24	O-120TBNL2442	O-120TBNR2442	7,637	+20	+174
48	24	O-120TBNL2448	O-120TBNR2448	8,807	+20	+192
54	24	O-120TBNL2454	O-120TBNR2454	9,462	+20	+228
60	24	O-120TBNL2460	O-120TBNR2460	10,116	+20	+246
36	30	O-120TBNL3036	O-120TBNR3036	7,467	+20	+192
42	30	O-120TBNL3042	O-120TBNR3042	8,121	+20	+228
48	30	O-120TBNL3048	O-120TBNR3048	9,293	+20	+246
54	30	O-120TBNL3054	O-120TBNR3054	9,947	+20	+285
60	30	O-120TBNL3060	O-120TBNR3060	10,602	+20	+309

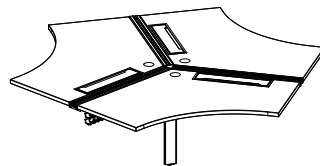
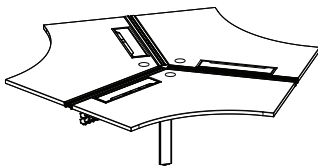

Specify

- Paint Selection for Spine Beam
- Paint Selection for Access Box
- Laminate Selection
- Edge Selection

Notes

- 120 Bench Top Kits - Powered with Access Box are designed for use with any Oxygen leg type.
- Center leg is included.
- Power is accessed through access box with flip door centered on the surface.
- Includes powerway, wire trough and spine beam for mounting screens.
- Order outlets and jumpers separately.
- Wood grain on bench tops runs parallel to spine beam.
- Width 36" and 42" accommodate (4) duplex outlets per seat. Widths 48" - 60" accommodate (8) duplex outlets.
- Access Boxes provide access to only 4 outlets.

120 Powered Bench Kits with Grommets

120 SINGLE-SIDED POWERED BENCH KIT WITH GROMMET

W	D	Model Number	List	Grade C Paint	Grade C Laminate
36	24	O-120SBPG2436	4,425	+20	+47
42	24	O-120SBPG2442	4,740	+20	+58
48	24	O-120SBPG2448	5,573	+20	+64
54	24	O-120SBPG2454	5,885	+20	+76
60	24	O-120SBPG2460	6,203	+20	+82
36	30	O-120SBPG3036	4,587	+20	+64
42	30	O-120SBPG3042	4,900	+20	+76
48	30	O-120SBPG3048	5,734	+20	+82
54	30	O-120SBPG3054	6,050	+20	+95
60	30	O-120SBPG3060	6,362	+20	+103

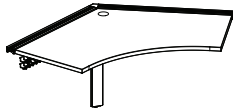

120 DOUBLE-SIDED POWERED BENCH KIT WITH GROMMET

W	D	Model Number	List	Grade C Paint	Grade C Laminate
36	24	O-120DBPG2436	6,883	+20	+94
42	24	O-120DBPG2442	7,416	+20	+116
48	24	O-120DBPG2448	8,726	+20	+128
54	24	O-120DBPG2454	9,258	+20	+152
60	24	O-120DBPG2460	9,793	+20	+164
36	30	O-120DBPG3036	7,206	+20	+128
42	30	O-120DBPG3042	7,739	+20	+152
48	30	O-120DBPG3048	9,048	+20	+164
54	30	O-120DBPG3054	9,580	+20	+190
60	30	O-120DBPG3060	10,114	+20	+206

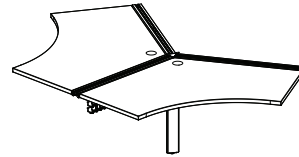

120 TRIPLE-SIDED POWERED BENCH KIT WITH GROMMET

W	D	Model Number	List	Grade C Paint	Grade C Laminate
36	24	O-120TBPG2436	7,986	+20	+141
42	24	O-120TBPG2442	8,639	+20	+174
48	24	O-120TBPG2448	10,068	+20	+192
54	24	O-120TBPG2454	10,722	+20	+228
60	24	O-120TBPG2460	11,376	+20	+246
36	30	O-120TBPG3036	8,471	+20	+192
42	30	O-120TBPG3042	9,124	+20	+228
48	30	O-120TBPG3048	10,553	+20	+246
54	30	O-120TBPG3054	11,207	+20	+285
60	30	O-120TBPG3060	11,861	+20	+309

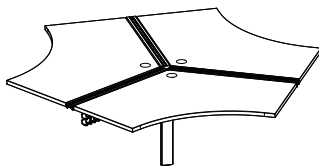

Specify

- Paint Selection for Spine Beam
- Grommet Color Selection
- Laminate Selection
- Edge Selection

Notes

- 120 Bench Top Kits - Powered Grommet are designed for use with any Oxygen leg type.
- Center leg is included.
- Power is accessed through a grommet centered on the surface.
- Includes powerway, wire trough and spine beam for mounting screens.
- Order outlets and jumpers separately.
- Wood grain on bench tops runs parallel to spine beam.
- Widths 36" and 42" accommodate (2) duplex outlets per seat. Widths 48" - 60" accommodate (4) duplex outlets.

120 Chicago Powered Bench Kits with Grommets

120 SINGLE-SIDED CHICAGO POWERED BENCH KIT WITH GROMMET

W	D	Model Number	List	Grade C Paint	Grade C Laminate
36	24	O-120HSBPG2436	4,425	+20	+47
42	24	O-120HSBPG2442	4,740	+20	+58
48	24	O-120HSBPG2448	5,573	+20	+64
54	24	O-120HSBPG2454	5,885	+20	+76
60	24	O-120HSBPG2460	6,203	+20	+82
36	30	O-120HSBPG3036	4,587	+20	+64
42	30	O-120HSBPG3042	4,900	+20	+76
48	30	O-120HSBPG3048	5,734	+20	+82
54	30	O-120HSBPG3054	6,050	+20	+95
60	30	O-120HSBPG3060	6,362	+20	+103

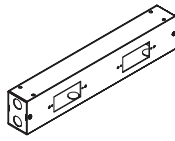
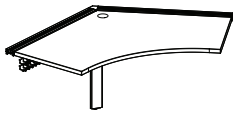

Hardwire Junction Box

120 DOUBLE-SIDED CHICAGO POWERED BENCH KIT WITH GROMMET

W	D	Model Number	List	Grade C Paint	Grade C Laminate
36	24	O-120HDBPG2436	6,883	+20	+94
42	24	O-120HDBPG2442	7,416	+20	+116
48	24	O-120HDBPG2448	8,726	+20	+128
54	24	O-120HDBPG2454	9,258	+20	+152
60	24	O-120HDBPG2460	9,793	+20	+164
36	30	O-120HDBPG3036	7,206	+20	+128
42	30	O-120HDBPG3042	7,739	+20	+152
48	30	O-120HDBPG3048	9,048	+20	+164
54	30	O-120HDBPG3054	9,580	+20	+190
60	30	O-120HDBPG3060	10,114	+20	+206

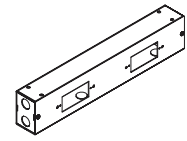
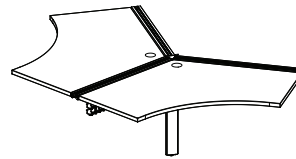

Hardwire Junction Box

120 TRIPLE-SIDED CHICAGO POWERED BENCH KIT WITH GROMMET

W	D	Model Number	List	Grade C Paint	Grade C Laminate
36	24	O-120HTBPG2436	7,986	+20	+141
42	24	O-120HTBPG2442	8,639	+20	+174
48	24	O-120HTBPG2448	10,068	+20	+192
54	24	O-120HTBPG2454	10,722	+20	+228
60	24	O-120HTBPG2460	11,376	+20	+246
36	30	O-120HTBPG3036	8,471	+20	+192
42	30	O-120HTBPG3042	9,124	+20	+228
48	30	O-120HTBPG3048	10,553	+20	+246
54	30	O-120HTBPG3054	11,207	+20	+285
60	30	O-120HTBPG3060	11,861	+20	+309

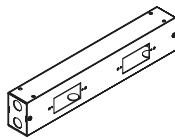
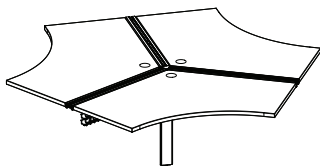

Hardwire Junction Box

Specify

- Paint Selection for Spine Beam
- Grommet Color Selection
- Laminate Selection
- Edge Selection

Notes

- 120 Bench Top Kits - Powered Grommet are designed for use with any Oxygen leg type.
- Center leg is included.
- Power is accessed through a grommet centered on the surface.
- Includes powerway, wire trough and spine beam for mounting screens.
- Order outlets and jumpers separately.
- Wood grain on bench tops runs parallel to spine beam.
- Widths 36" and 42" accommodate (2) duplex outlets per seat. Widths 48" - 60" accommodate (4) duplex outlets.

120 Non-Powered Bench Kits with Grommets

120 SINGLE-SIDED NON-POWERED BENCH KIT WITH GROMMET

W	D	Model Number	List	Grade C Paint	Grade C Laminate
36	24	O-120SBNG2436	2,973	+20	+47
42	24	O-120SBNG2442	3,288	+20	+58
48	24	O-120SBNG2448	3,601	+20	+64
54	24	O-120SBNG2454	3,915	+20	+76
60	24	O-120SBNG2460	4,233	+20	+82
36	30	O-120SBNG3036	3,131	+20	+64
42	30	O-120SBNG3042	3,448	+20	+76
48	30	O-120SBNG3048	3,763	+20	+82
54	30	O-120SBNG3054	4,075	+20	+95
60	30	O-120SBNG3060	4,394	+20	+103

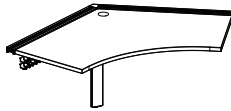

120 DOUBLE-SIDED NON-POWERED BENCH KIT WITH GROMMET

W	D	Model Number	List	Grade C Paint	Grade C Laminate
36	24	O-120DBNG2436	4,720	+20	+94
42	24	O-120DBNG2442	5,253	+20	+116
48	24	O-120DBNG2448	6,301	+20	+128
54	24	O-120DBNG2454	6,834	+20	+152
60	24	O-120DBNG2460	7,368	+20	+164
36	30	O-120DBNG3036	5,041	+20	+128
42	30	O-120DBNG3042	5,575	+20	+152
48	30	O-120DBNG3048	6,625	+20	+164
54	30	O-120DBNG3054	7,159	+20	+190
60	30	O-120DBNG3060	7,690	+20	+206

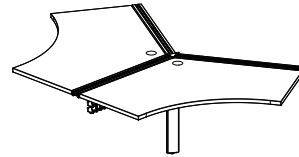

120 TRIPLE-SIDED POWERED BENCH KIT WITH GROMMET

W	D	Model Number	List	Grade C Paint	Grade C Laminate
36	24	O-120TBNG2436	5,821	+20	+141
42	24	O-120TBNG2442	6,475	+20	+174
48	24	O-120TBNG2448	7,645	+20	+192
54	24	O-120TBNG2454	8,300	+20	+228
60	24	O-120TBNG2460	8,956	+20	+246
36	30	O-120TBNG3036	6,303	+20	+192
42	30	O-120TBNG3042	6,960	+20	+228
48	30	O-120TBNG3048	8,131	+20	+246
54	30	O-120TBNG3054	8,784	+20	+285
60	30	O-120TBNG3060	9,440	+20	+309

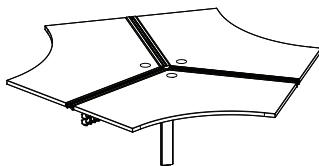

Specify

- Paint Selection for Spine Beam
- Grommet Color Selection
- Laminate Selection
- Edge Selection

Notes

- 120 Bench Top Kits - Powered Grommet are designed for use with any Oxygen leg type.
- Center leg is included.
- Power is accessed through a grommet centered on the surface. Includes powerway, wire trough and spine beam for mounting screens.
- Order outlets and jumpers separately.
- Wood grain on bench tops runs parallel to spine beam.
- Widths 36" and 42" accommodate (2) duplex outlets per seat. Widths 48" - 60" accommodate (4) duplex outlets.

Rectangular Returns

RECTANGULAR RETURN SURFACES				
Actual W	D	Model Number	List	Grade C Laminate
23.75	18	W-OSR1824	397	+21
29.75	18	W-OSR1830	471	+25
35.75	18	W-OSR1836	512	+28
41.75	18	W-OSR1842	556	+30
47.75	18	W-OSR1848	602	+33
53.75	18	W-OSR1854	746	+41
59.75	18	W-OSR1860	746	+41
65.75	18	W-OSR1866	843	+46
71.75	18	W-OSR1872	922	+51
23.75	22	W-OSR2224	397	+21
29.75	22	W-OSR2230	471	+25
35.75	22	W-OSR2236	512	+28
41.75	22	W-OSR2242	556	+30
47.75	22	W-OSR2248	602	+33
53.75	22	W-OSR2254	746	+41
59.75	22	W-OSR2260	746	+41
65.75	22	W-OSR2266	843	+46
71.75	22	W-OSR2272	922	+51

RECTANGULAR RETURN SURFACES				
Actual W	D	Model Number	List	Grade C Laminate
23.75	24	W-OSR2424	397	+21
29.75	24	W-OSR2430	471	+25
35.75	24	W-OSR2436	512	+28
41.75	24	W-OSR2442	556	+30
47.75	24	W-OSR2448	602	+33
53.75	24	W-OSR2454	746	+41
59.75	24	W-OSR2460	746	+41
65.75	24	W-OSR2466	843	+46
71.75	24	W-OSR2472	922	+51
23.75	30	W-OSR3024	471	+25
29.75	30	W-OSR3030	553	+30
35.75	30	W-OSR3036	621	+34
41.75	30	W-OSR3042	714	+39
47.75	30	W-OSR3048	774	+42
53.75	30	W-OSR3054	901	+50
59.75	30	W-OSR3060	901	+50
65.75	30	W-OSR3066	1,018	+56
71.75	30	W-OSR3072	1,105	+61

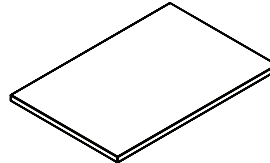

Specify

- Laminate Selection
- Edge Selection

Notes

- Return Surfaces - Rectangular are standard return surfaces designed to work with Oxygen.
- Wood grain on return runs the width of the surface.

Slant Returns

SLANTED RETURN SURFACES (LEFT)

Actual W	D (Left)	D (Right)	Model Number	List	Grade C Laminate
23.75	24	18	W-OSRL1824	397	+21
29.75	24	18	W-OSRL1830	471	+25
35.75	24	18	W-OSRL1836	512	+28
41.75	24	18	W-OSRL1842	556	+30
47.75	24	18	W-OSRL1848	602	+33
53.75	24	18	W-OSRL1854	746	+41
59.75	24	18	W-OSRL1860	746	+41
65.75	24	18	W-OSRL1866	843	+46
71.75	24	18	W-OSRL1872	922	+51
23.75	30	24	W-OSRL2424	397	+21
29.75	30	24	W-OSRL2430	471	+25
35.75	30	24	W-OSRL2436	512	+28
41.75	30	24	W-OSRL2442	556	+30
47.75	30	24	W-OSRL2448	602	+33
53.75	30	24	W-OSRL2454	746	+41
59.75	30	24	W-OSRL2460	746	+41
65.75	30	24	W-OSRL2466	843	+46
71.75	30	24	W-OSRL2472	922	+51
23.75	36	30	W-OSRL3024	471	+25
29.75	36	30	W-OSRL3030	553	+30
35.75	36	30	W-OSRL3036	621	+34
41.75	36	30	W-OSRL3042	714	+39
47.75	36	30	W-OSRL3048	774	+42
53.75	36	30	W-OSRL3054	901	+50
59.75	36	30	W-OSRL3060	901	+50
65.75	36	30	W-OSRL3066	1,018	+56
71.75	36	30	W-OSRL3072	1,105	+61

SLANTED RETURN SURFACES (RIGHT)

Actual W	D (Left)	D (Right)	Model Number	List	Laminate Grade C
23.75	18	24	W-OSRR1824	397	+21
29.75	18	24	W-OSRR1830	471	+25
35.75	18	24	W-OSRR1836	512	+28
41.75	18	24	W-OSRR1842	556	+30
47.75	18	24	W-OSRR1848	602	+33
53.75	18	24	W-OSRR1854	746	+41
59.75	18	24	W-OSRR1860	746	+41
65.75	18	24	W-OSRR1866	843	+46
71.75	18	24	W-OSRR1872	922	+51
23.75	24	30	W-OSRR2424	397	+21
29.75	24	30	W-OSRR2430	471	+25
35.75	24	30	W-OSRR2436	512	+28
41.75	24	30	W-OSRR2442	556	+30
47.75	24	30	W-OSRR2448	602	+33
53.75	24	30	W-OSRR2454	746	+41
59.75	24	30	W-OSRR2460	746	+41
65.75	24	30	W-OSRR2466	843	+46
71.75	24	30	W-OSRR2472	922	+51
23.75	30	36	W-OSRR3024	471	+25
29.75	30	36	W-OSRR3030	553	+30
35.75	30	36	W-OSRR3036	621	+34
41.75	30	36	W-OSRR3042	714	+39
47.75	30	36	W-OSRR3048	774	+42
53.75	30	36	W-OSRR3054	901	+50
59.75	30	36	W-OSRR3060	901	+50
65.75	30	36	W-OSRR3066	1,018	+56
71.75	30	36	W-OSRR3072	1,105	+61

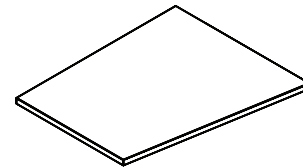
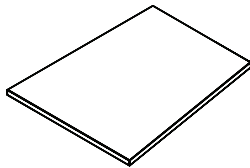

Specify

- Laminate Selection
- Edge Selection

Notes

- Motorized and fixed slant return includes surface for mounting for 24" deep or 30" deep benches.
- Motorized base with 1" glide adjustment and 20" height adjustment from 27.5" to 48.5" high, LED programmable hand switch with four memory presets, vertical travel speed is approximately 1.4" per second.
- **Important:** Fixed rectangular returns cannot be used with motorized benches.

Return Support Rails

RETURNS WITHOUT STRUCTURAL PEDESTAL SUPPORT RAIL

L	Model Number	List	Return Length
36	O-RSR36	551	36"W Return
42	O-RSR42	574	42"W Return
48	O-RSR48	591	48"W Return
54	O-RSR54	613	54"W Return
60	O-RSR60	633	60"W Return
66	O-RSR66	654	66"W Return
72	O-RSR72	674	72"W Return

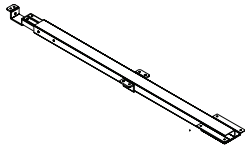

RETURNS WITH STRUCTURAL PEDESTAL SUPPORT RAIL

L	Model Number	List	Return Length
36	O-RSR36	551	54"W Return
42	O-RSR42	574	60"W Return
48	O-RSR48	591	66"W Return
54	O-RSR54	613	72"W Return

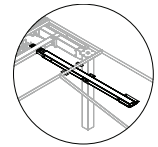
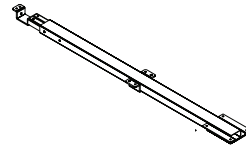

Notes

- Return Support Rail is used as a structural support when attaching a return surface to an Oxygen bench.
- Specify the rail to match the surface width, unless a structural pedestal is used on the return.
- Return length with structural pedestal detail is below.

Return Strips

NO SCREEN CLAMP RETURN STRIP

Length	Actual Length	Model Number	List
18	18	O-RSF18	46
20	20	O-RSF20	53
22	22	O-RSF22	58
24	24	O-RSF24	62
30	30	O-RSF30	74
36	36	O-RSF36	87
42	42	O-RSF42	103
48	48	O-RSF48	115

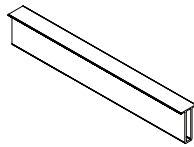

SCREEN CLAMP RETURN STRIP (END OF RETURN)

Length	Actual Length	Model Number	List
18	15.25	O-RSF15	46
20	17.25	O-RSF17	53
22	19.25	O-RSF19	58
24	21.25	O-RSF21	62
30	27.25	O-RSF27	74
36	33.25	O-RSF33	87
42	39.25	O-RSF39	103
48	45.25	O-RSF45	115

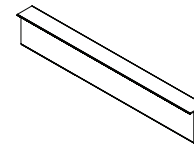

SCREEN CLAMP RETURN STRIP (CENTER OF RETURN)

Length	Actual Length	Model Number	List
18	15.25	O-RSF15S	46
20	17.25	O-RSF17S	53
22	19.25	O-RSF19S	58
24	21.25	O-RSF21S	62
30	27.25	O-RSF27S	74
36	33.25	O-RSF33S	87
42	39.25	O-RSF39S	103
48	45.25	O-RSF45S	115

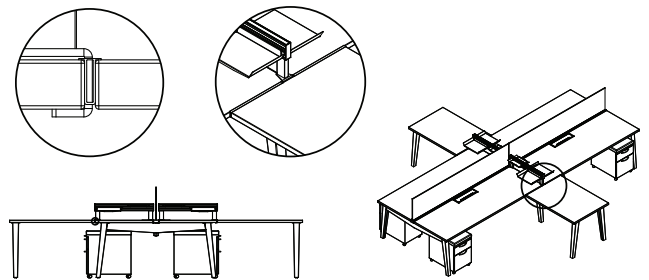
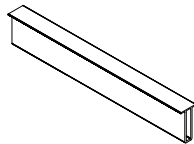

Notes

- Return Strip is needed when mounting return surfaces adjacent to territory screen/toolbar to fill gap created by screen mounting brackets.

Straight Leg Kits

SINGLE-SIDED BENCH STRAIGHT LEG KITS (LEFT)

H	D	Model Number	List	Grade C Paint
27	24	O-STLBSB24L	884	+25
27	30	O-STLBSB30L	913	+25

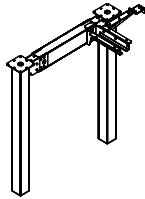

SINGLE-SIDED BENCH STRAIGHT LEG KITS (RIGHT)

H	D	Model Number	List	Grade C Paint
27	24	O-STLBSB24R	884	+25
27	30	O-STLBSB30R	913	+25

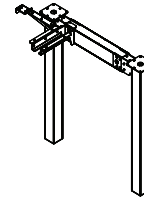

DOUBLE-SIDED BENCH STRAIGHT LEG KITS

H	D	Model Number	List	Grade C Paint
27	48	O-STLBDB48	1,239	+25
27	60	O-STLBDB60	1,306	+25

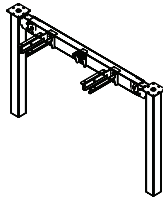

Specify

Notes

- Paint Selection

- Straight Leg Kits - End-of-Run are designed for use at the end-of-run of a bench layout.
- For use with all top widths.

SINGLE-SIDED BENCH STRAIGHT LEG KITS (SHARED)

H	D	Model Number	List	Grade C Paint
27	24	O-STBSBSK24	1,133	+25
27	30	O-STBSBSK30	1,156	+25

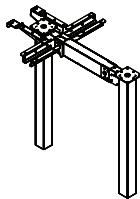

DOUBLE-SIDED BENCH STRAIGHT LEG KITS (SHARED)

H	D	Model Number	List	Grade C Paint
27	36	O-STBDBSK36	1,684	+25
27	48	O-STBDBSK48	1,741	+25
27	60	O-STBDBSK60	1,802	+25

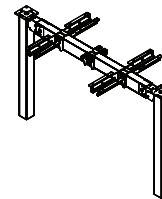

Specify

Notes

- Paint Selection

- Straight Leg Kits - Shared are designed for use in shared applications in a bench layout.
- For use with all top widths.

Slim Leg Kits

SINGLE-SIDED BENCH SLIM LEG KITS (LEFT)

H	D	Model Number	List	Grade C Paint
27	24	O-SMLBSB24L	1,025	+25
27	30	O-SMLBSB30L	1,099	+25

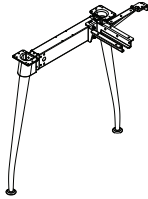

SINGLE-SIDED BENCH SLIM LEG KITS (RIGHT)

H	D	Model Number	List	Grade C Paint
27	24	O-SMLBSB24R	1,025	+25
27	30	O-SMLBSB30R	1,099	+25

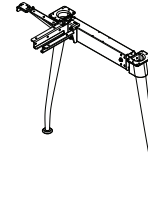

DOUBLE-SIDED BENCH SLIM LEG KITS

H	D	Model Number	List	Grade C Paint
27	36	O-SMLBDB36	1,428	+25
27	48	O-SMLBDB48	1,428	+25
27	60	O-SMLBDB60	1,493	+25

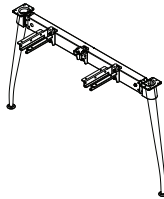

Specify

Notes

- Paint Selection for Top
- Paint Selection for Leg

- Slim Leg Kits - End-of-Run are designed for use at the end-of-run of a bench layout.
- For use with all top widths.

SINGLE-SIDED BENCH SLIM LEG KITS (SHARED)

H	D	Model Number	List	Grade C Paint
27	24	O-SMBSBSK24	1,320	+25
27	30	O-SMBSBSK30	1,348	+25

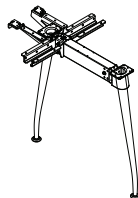

DOUBLE-SIDED BENCH SLIM LEG KITS (SHARED)

H	D	Model Number	List	Grade C Paint
27	36	O-SMBDBSK36	1,871	+25
27	48	O-SMBDBSK48	1,928	+25
27	60	O-SMBDBSK60	1,992	+25

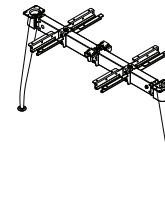

Specify

Notes

- Paint Selection for Top
- Paint Selection for Leg

- Slim Leg Kits - Shared are designed for use in shared applications in a bench layout.
- For use with all top widths.

Slant Leg Kits

SINGLE-SIDED BENCH SLANT LEG KITS (LEFT)

H	D	Model Number	List	Grade C Paint
27	24	O-SLLBSBK24L	2,035	+25
27	30	O-SLLBSBK30L	2,100	+25

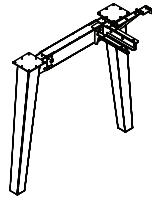

SINGLE-SIDED BENCH SLANT LEG KITS (RIGHT)

H	D	Model Number	List	Grade C Paint
27	24	O-SLLBSBK24R	2,035	+25
27	30	O-SLLBSBK30R	2,100	+25

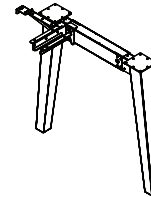

DOUBLE-SIDED BENCH SLANT LEG KITS

H	D	Model Number	List	Grade C Paint
27	36	O-SLLBDBK36	2,286	+25
27	48	O-SLLBDBK48	2,286	+25
27	60	O-SLLBDBK60	2,349	+25

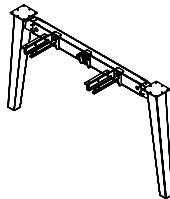

Specify

Notes

- Paint Selection

- Slant Leg Kits - End-of-Run are designed for use at the end-of-run of a bench layout.
- For use with all top widths.

SINGLE-SIDED BENCH SLANT LEG KITS (SHARED)

H	D	Model Number	List	Grade C Paint
27	24	O-SLLDBSK24	2,286	+25
27	30	O-SLLDBSK30	2,349	+25

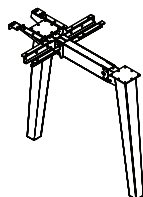

DOUBLE-SIDED BENCH SLANT LEG KITS (SHARED)

H	D	Model Number	List	Grade C Paint
27	36	O-SLLDBSK36	2,730	+25
27	48	O-SLLDBSK48	2,785	+25
27	60	O-SLLDBSK60	2,847	+25

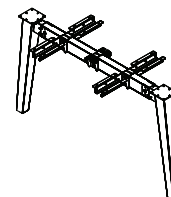

Specify

Notes

- Paint Selection

- Slant Leg Kits - Shared are designed for use in shared applications in a bench layout.
- For use with all top widths.

Stand-Alone Single Legs

STRAIGHT STAND-ALONE LEGS

H	Model Number	List	Grade C Paint
27	O-PL2525	364	+25



Specify	Notes
<ul style="list-style-type: none"> • Paint Selection 	<ul style="list-style-type: none"> • Stand-Alone Single Legs are used to support returns and end tables. • For use with any top width.

STRAIGHT MOBILE STAND-ALONE LEGS

H	Model Number	List	Grade C Paint
27	O-PL2525M	354	+25



Specify	Notes
<ul style="list-style-type: none"> • Paint Selection 	<ul style="list-style-type: none"> • Stand-Alone Single Legs are used to support returns and end tables. • For use with any top width.

SLIM STAND-ALONE LEGS

H	Model Number	List	Grade C Paint
27	O-SMSG	405	+25



Specify	Notes
<ul style="list-style-type: none"> • Paint Selection 	<ul style="list-style-type: none"> • Stand-Alone Single Legs are used to support returns and end tables. • For use with any top width.

SLIM MOBILE STAND-ALONE LEGS

H	Model Number	List	Grade C Paint
27	O-SMSCASTER	349	+25



Specify	Notes
<ul style="list-style-type: none"> • Paint Selection 	<ul style="list-style-type: none"> • Stand-Alone Single Legs are used to support returns and end tables. • For use with any top width.

SLANT STAND-ALONE LEGS

H	Model Number	List	Grade C Paint
27	O-SL	671	+25



Specify	Notes
<ul style="list-style-type: none"> • Paint Selection 	<ul style="list-style-type: none"> • Stand-Alone Single Legs are used to support returns and end tables. • For use with any top width.

Laminate End Panels

SINGLE-SIDED END PANEL (LEFT)

H	W	Model Number	List	Grade C Laminate
28	24	O-2LBSB2824L	887	+60
28	30	O-2LBSB2830L	956	+64
42	24	O-2LBSB4224L	984	+56
42	30	O-2LBSB4230L	1,072	+68
46	24	O-2LBSB4624L	1,016	+74
46	30	O-2LBSB4630L	1,109	+86
50	24	O-2LBSB5024L	1,051	+76
50	30	O-2LBSB5030L	1,152	+84

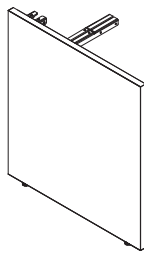

SINGLE-SIDED END PANEL (RIGHT)

H	W	Model Number	List	Laminate Grade C
28	24	O-2LBSB2824R	887	+60
28	30	O-2LBSB2830R	956	+64
42	24	O-2LBSB4224R	984	+56
42	30	O-2LBSB4230R	1,072	+68
46	24	O-2LBSB4624R	1,016	+74
46	30	O-2LBSB4630R	1,109	+86
50	24	O-2LBSB5024R	1,051	+76
50	30	O-2LBSB5030R	1,152	+84

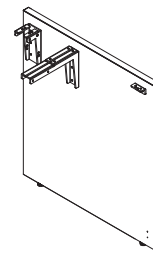

DOUBLE-SIDED END PANEL

H	W	Model Number	List	Laminate Grade C
28	48	O-2LBDB2848	1,449	+84
28	60	O-2LBDB2860	1,575	+100
42	48	O-2LBDB4248	1,641	+106
42	60	O-2LBDB4260	1,817	+136
46	48	O-2LBDB4648	1,703	+114
46	60	O-2LBDB4660	1,897	+134
50	48	O-2LBDB5048	1,765	+120
50	60	O-2LBDB5060	1,975	+134

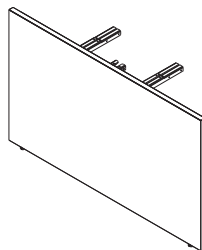

Specify

- Laminate Selection
- Edge Selection

Notes

- End-of-Run Kits are designed for use at the end-of-run of a bench layout.
- Laminate end-of-run kits sit beside the bench layout with the edgeband at worksurface height.
- Laminate end panels add 1" to the bench length.
- Wood grain on end panels 18"W – 60"W runs vertically while panels 66"W – 96"W run horizontally.
- Laminate end panels have a top width of 36" - 72".

Laminate End Panels

MID-RUN END PANEL (LEFT)				
H	W	Model Number	List	Laminate Grade C
28	24	O-2LMREP2824L	1,221	+50
28	30	O-2LMREP2830L	1,281	+30
42	24	O-2LMREP4224L	1,316	+60
42	30	O-2LMREP4230L	1,402	+78
46	24	O-2LMREP4624L	1,350	+66
46	30	O-2LMREP4630L	1,441	+84
50	24	O-2LMREP5024L	1,376	+82
50	30	O-2LMREP5030L	1,482	+100

MID-RUN END PANEL (RIGHT)				
H	W	Model Number	List	Laminate Grade C
28	24	O-2LMREP2824R	1,221	+50
28	30	O-2LMREP2830R	1,281	+30
42	24	O-2LMREP4224R	1,316	+60
42	30	O-2LMREP4230R	1,402	+78
46	24	O-2LMREP4624R	1,350	+66
46	30	O-2LMREP4630R	1,441	+84
50	24	O-2LMREP5024R	1,376	+82
50	30	O-2LMREP5030R	1,482	+100

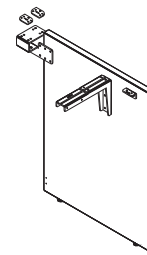
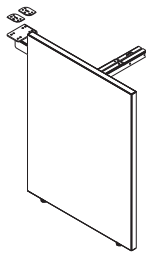

Specify

- Laminate Selection
- Edge Selection

Notes

- Mid-Run Kits are designed for use at a mid-run bench location.
- Laminate mid-run kits sit beside the bench layout with the edgeband at worksurface height.
- Wood grain on end panels 18"W – 60"W runs vertically while panels 66"W – 96"W run horizontally.
- Laminate mid-run kits have a top width of 36" - 72".

Full Modesty Panels for Rectangular Benches

FULL-HEIGHT MODESTY PANELS

H	D	Model Number	List	Laminate Grade C	H	D	Model Number	List	Laminate Grade C
28	36	O-MLSTSB2836	745	+66	46	36	O-MLSTSB4636	1,305	+66
28	42	O-MLSTSB2842	842	+78	46	42	O-MLSTSB4642	1,487	+78
28	48	O-MLSTSB2848	989	+84	46	48	O-MLSTSB4648	1,736	+84
28	54	O-MLSTSB2854	1,090	+100	46	54	O-MLSTSB4654	1,917	+100
28	60	O-MLSTSB2860	1,198	+100	46	60	O-MLSTSB4660	2,119	+100
28	66	O-MLSTSB2866	1,238	+112	46	66	O-MLSTSB4666	2,208	+112
28	72	O-MLSTSB2872	1,326	+123	46	72	O-MLSTSB4672	2,368	+123
28	78	O-MLSTSB2878	1,412	+146	46	78	O-MLSTSB4678	2,526	+146
28	84	O-MLSTSB2884	1,495	+152	46	84	O-MLSTSB4684	2,688	+152
28	90	O-MLSTSB2890	1,620	+161	46	90	O-MLSTSB4690	2,909	+161
28	96	O-MLSTSB2896	1,719	+169	46	96	O-MLSTSB4696	3,089	+169
42	36	O-MLSTSB4236	1,258	+66	50	36	O-MLSTSB5036	1,353	+66
42	42	O-MLSTSB4242	1,481	+78	50	42	O-MLSTSB5042	1,539	+78
42	48	O-MLSTSB4248	1,672	+84	50	48	O-MLSTSB5048	1,800	+84
42	54	O-MLSTSB4254	1,846	+100	50	54	O-MLSTSB5054	1,991	+100
42	60	O-MLSTSB4260	2,035	+100	50	60	O-MLSTSB5060	2,197	+100
42	66	O-MLSTSB4266	2,122	+112	50	66	O-MLSTSB5066	2,294	+112
42	72	O-MLSTSB4272	2,273	+123	50	72	O-MLSTSB5072	2,465	+123
42	78	O-MLSTSB4278	2,426	+146	50	78	O-MLSTSB5078	2,630	+146
42	84	O-MLSTSB4284	2,575	+152	50	84	O-MLSTSB5084	2,801	+152
42	90	O-MLSTSB4290	2,787	+161	50	90	O-MLSTSB5090	3,030	+161
42	96	O-MLSTSB4296	2,962	+169	50	96	O-MLSTSB5096	3,217	+169

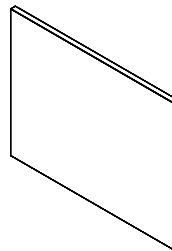

Specify

- Laminate Selection
- Edge Selection

Notes

- Full-Height modesties provide visual privacy for bench layouts.
- Laminate modesty panels sit beside the bench layout with the edgeband at worksurface height, and add 1” to the bench depth.
- Modesty panels cover the back of the electrical and data troughs where exposed on an aisle.
- Modesty panels are needed for structural support.
- Wood grain on end panels modesty panels 18”W – 60”W runs vertically while panels 66”W – 96”W run horizontally.

120 Modesty Panels and 120 Modesty Covers

120 SINGLE BENCH FULL MODESTY PANELS

H	W	Model Number Condition G	List	Laminate Grade C
29	36	B-120SBFMG36	1,053	+66
29	42	B-120SBFMG42	1,195	+78
29	48	B-120SBFMG48	1,404	+84
29	54	B-120SBFMG54	1,545	+100
29	60	B-120SBFMG60	1,706	+100

120 DOUBLE BENCH FULL MODESTY

H	W	Model Number Condition K	List	Laminate Grade C
29	36	B-120DBFMK36	1,053	+66
29	42	B-120DBFMK42	1,195	+78
29	48	B-120DBFMK48	1,404	+84
29	54	B-120DBFMK54	1,545	+100
29	60	B-120DBFMK60	1,706	+100

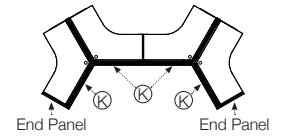
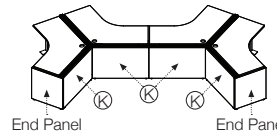
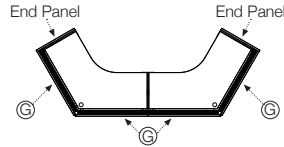
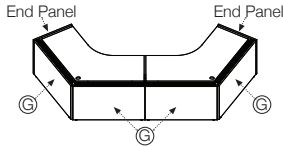

Specify

- Laminate Selection
- Edge Selection

Notes

- Modesties are non-structural cosmetic applications.
- For use with Oxygen 120 Bench Kits only.

120 SINGLE BENCH HALF MODESTY

H	W	Model Number Condition G	List	Laminate Grade C
10	36	B-120SBHMG36	511	+66
10	42	B-120SBHMG42	526	+78
10	48	B-120SBHMG48	542	+84
10	54	B-120SBHMG54	629	+100
10	60	B-120SBHMG60	637	+100

120 DOUBLE BENCH HALF MODESTY

H	W	Model Number Condition K	List	Laminate Grade C
10	36	B-120DBHMK36	511	+66
10	42	B-120DBHMK42	526	+78
10	48	B-120DBHMK48	542	+84
10	54	B-120DBHMK54	629	+100
10	60	B-120DBHMK60	637	+100

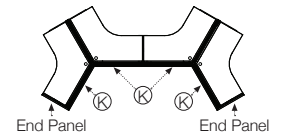
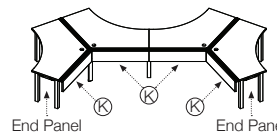
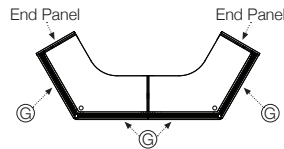
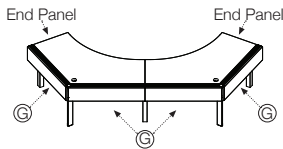

Specify

- Laminate Selection
- Edge Selection

Notes

- Modesties are non-structural cosmetic applications.
- For use with Oxygen 120 Bench Kits only.

120 SINGLE BENCH FULL MODESTY COVER

Model Number	List
B-120DBFMC	246

120 SINGLE BENCH HALF MODESTY COVER

Model Number	List
B-120DBHMC	246

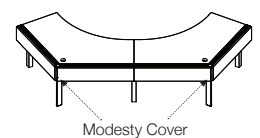
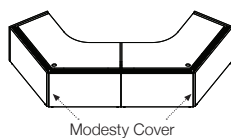

Specify

- Paint Selection

Notes

- Use to cover connecting gap between single bench modesty panels.

Specify

- Paint Selection

Notes

- Use to cover connecting gap between single bench modesty panels.

End-of-Run Covers

STRAIGHT LEG END-OF-RUN COVERS (FLAT)

H	D	Model Number	List	Grade C Paint
3.6	24	O-ECSFSB24	167	+10
3.6	30	O-ECSFSB30	184	+10
3.6	48	O-ECSFDB48	234	+10
3.6	60	O-ECSFDB60	251	+10

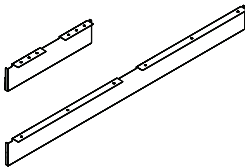

STRAIGHT LEG END-OF-RUN COVERS (TAPERED)

H	D	Model Number	List	Grade C Paint
3.6 - 5.1	24	O-ECSTSB24	167	+10
3.6 - 5.1	30	O-ECSTSB30	184	+10
3.6 - 5.1	48	O-ECSTDB48	234	+10
3.6 - 5.1	60	O-ECSTDB60	251	+10

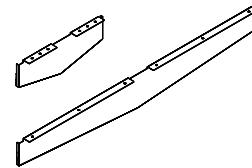

SLANT LEG END-OF-RUN COVERS (FLAT)

H	D	Model Number	List	Grade C Paint
3.6	24	O-ECSLFDB24	164	+10
3.6	30	O-ECSLFDB30	179	+10
3.6	48	O-ECSLFDB48	227	+10
3.6	60	O-ECSLFDB60	246	+10

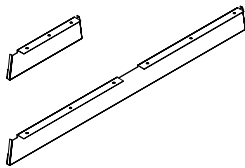

SLANT LEG END-OF-RUN COVERS (TAPERED)

H	D	Model Number	List	Grade C Paint
3.6 - 5.1	24	O-ECSLSB24	167	+10
3.6 - 5.1	30	O-ECSLSB30	184	+10
3.6 - 5.1	48	O-ECSLDB48	234	+10
3.6 - 5.1	60	O-ECSLDB60	251	+10

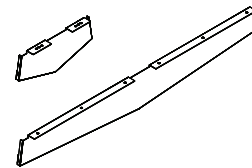

SLIM LEG END-OF-RUN COVERS (FLAT)

H	D	Model Number	List	Grade C Paint
3.6	24	O-ECSL24	167	+10
3.6	30	O-ECSL30	183	+10
3.6	48	O-ECSL48	233	+10
3.6	60	O-ECSL60	250	+10

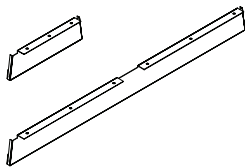

Specify

• Paint Selection

Notes

- End-of-Run Covers are designed to give the leg kits a finished look at the end of a bench run.
- Straight end-of-run covers are 3.6" high.
- Tapered end-of-run covers are 3.6" high at the end and angle down to 5.1" in the center.

Gallery Panels

TYPE A GALLERY PANELS (FEMALE ONE END)

H	W	Handing	Horizon Planning	Model Number	List	Laminate Grade C
27	12	Universal	Under Desk	O-GPF1E2712	443	+20
27	18	Universal	Under Desk	O-GPF1E2718	591	+24

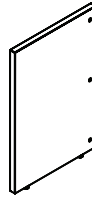

Specify

Notes

- Laminate Selection
- Edge Selection

- Gallery Panels (Type A) - Female One End are used with male gallery panels to support return surfaces and create privacy.
- Female one end gallery panels are positioned under the worksurface for support.
- Wood grain on gallery panels 18"W – 60"W runs vertically while panels 66"W – 96"W run horizontally.

TYPE B GALLERY PANELS (FEMALE ONE END)

H	W	Horizon Planning	Left Handed		Right Handed		Laminate Grade C
			Model Number	List	Model Number	List	
28	18	Desktop	O-GPF1E2818L	443	O-GPF1E2818R	443	+36
28	20	Desktop	O-GPF1E2820L	591	O-GPF1E2820R	591	+41
28	24	Desktop	O-GPF1E2824L	741	O-GPF1E2824R	741	+46
42	18	42"H	O-GPF1E4218L	516	O-GPF1E4218R	516	+46
42	20	42"H	O-GPF1E4220L	674	O-GPF1E4220R	674	+51
42	24	42"H	O-GPF1E4224L	839	O-GPF1E4224R	839	+56
46	18	46"H	O-GPF1E4618L	542	O-GPF1E4618R	542	+61
46	20	46"H	O-GPF1E4620L	699	O-GPF1E4620R	699	+67
46	24	46"H	O-GPF1E4624L	869	O-GPF1E4624R	869	+73
50	18	50"H	O-GPF1E5018L	567	O-GPF1E5018R	567	+78
50	20	50"H	O-GPF1E5020L	727	O-GPF1E5020R	727	+84
50	24	50"H	O-GPF1E5024L	900	O-GPF1E5024R	900	+90



Left Hand



Right Hand

Specify

Notes

- Laminate Selection
- Edge Selection

- Gallery Panels (Type B) - Female One End (Handed) are used with male gallery panels to support return surfaces and create privacy.
- Female one end gallery panels are positioned adjacent to the worksurface for support.
- Wood grain on gallery panels 18"W – 60"W runs vertically while panels 66"W – 96"W run horizontally.

TYPE C GALLERY PANELS (MALE BOTH ENDS)

H	W	Horizon Planning	Model Number	List	Laminate Grade C	Handing
28	24	Desktop	O-GPM2E2824	741	+46	Universal
28	30	Desktop	O-GPM2E2830	964	+51	Universal
28	36	Desktop	O-GPM2E2836	1,109	+56	Universal
28	42	Desktop	O-GPM2E2842	1,263	+61	Universal
28	48	Desktop	O-GPM2E2848	1,481	+67	Universal
28	54	Desktop	O-GPM2E2854	1,631	+71	Universal
28	54	Desktop	O-GPM2E2860	1,797	+76	Universal
42	24	42"H	O-GPM2E4224	813	+58	Universal
42	30	42"H	O-GPM2E4230	1,037	+61	Universal
42	36	42"H	O-GPM2E4236	1,185	+65	Universal
42	42	42"H	O-GPM2E4242	1,332	+68	Universal
42	48	42"H	O-GPM2E4248	1,554	+71	Universal
42	54	42"H	O-GPM2E4254	1,705	+76	Universal
42	60	42"H	O-GPM2E4260	1,870	+80	Universal
46	24	46"H	O-GPM2E4624	839	+73	Universal
46	30	46"H	O-GPM2E4630	1,061	+76	Universal
46	36	46"H	O-GPM2E4636	1,208	+80	Universal
46	42	46"H	O-GPM2E4642	1,357	+83	Universal
46	48	46"H	O-GPM2E4648	1,554	+87	Universal
46	54	46"H	O-GPM2E4654	1,730	+90	Universal
46	60	46"H	O-GPM2E4660	1,894	+94	Universal
50	24	50"H	O-GPM2E5024	862	+90	Universal
50	30	50"H	O-GPM2E5030	1,085	+94	Universal
50	36	50"H	O-GPM2E5036	1,232	+97	Universal
50	42	50"H	O-GPM2E5042	1,381	+102	Universal
50	48	50"H	O-GPM2E5048	1,601	+105	Universal
50	54	50"H	O-GPM2E5054	1,753	+109	Universal
50	60	50"H	O-GPM2E5060	1,916	+115	Universal

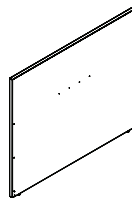

Specify

- Laminate Selection
- Edge Selection

Notes

- Gallery Panels (Type C) - Male Both Ends are used with female gallery panels to support returns and create privacy.
- Male both end gallery panels are positioned adjacent to the worksurface for support.
- Actual width is nominal plus 1 1/8" to accommodate female gallery panel on one end.
- Wood grain on gallery panels 18"W – 60"W runs vertically while panels 66"W – 96"W run horizontally.

Gallery Panels

TYPE D GALLERY PANELS (MALE CENTERED)

H	W	Horizon Planning	Model Number	List	Laminate Grade C	Handing
28	24	Under Desk	O-GPMC2824	741	+46	Non-Handed
28	30	Under Desk	O-GPMC2830	964	+51	Non-Handed
28	36	Under Desk	O-GPMC2836	1,109	+56	Non-Handed
28	42	Under Desk	O-GPMC2842	1,263	+61	Non-Handed
28	48	Under Desk	O-GPMC2848	1,481	+67	Non-Handed
42	24	42"H	O-GPMC4224	813	+58	Non-Handed
42	30	42"H	O-GPMC4230	1,037	+61	Non-Handed
42	36	42"H	O-GPMC4236	1,185	+65	Non-Handed
42	42	42"H	O-GPMC4242	1,332	+68	Non-Handed
42	48	42"H	O-GPMC4248	1,554	+71	Non-Handed
46	24	46"H	O-GPMC4624	839	+73	Non-Handed
46	30	46"H	O-GPMC4630	1,061	+76	Non-Handed
46	36	46"H	O-GPMC4636	1,208	+80	Non-Handed
46	46	46"H	O-GPMC4642	1,357	+83	Non-Handed
46	48	46"H	O-GPMC4648	1,576	+87	Non-Handed
50	24	50"H	O-GPMC5024	862	+90	Non-Handed
50	30	50"H	O-GPMC5030	1,085	+94	Non-Handed
50	36	50"H	O-GPMC5036	1,232	+97	Non-Handed
50	42	50"H	O-GPMC5042	1,381	+102	Non-Handed
50	48	50"H	O-GPMC5048	1,600	+105	Non-Handed

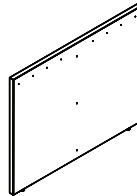

Specify

- Laminate Selection
- Edge Selection

Notes

- Gallery Panels (Type B) - Female One End (Handed) are used with male gallery panels to support return surfaces and create privacy.
- Female one end gallery panels are positioned adjacent to the worksurface for support.
- Wood grain on gallery panels 18"W – 60"W runs vertically while panels 66"W - 96"W run horizontally.

Duplex Outlets

DUPLEX OUTLETS

Line	Color	Model Number	List
1	Black	E-MW8W4DO1	91
2	Black	E-MW8W4DO2	91
3	Black	E-MW8W4DO3	91
4	Black	E-MW8W4DO4	91
1	White	E-MW8W4DO1-W	91
2	White	E-MW8W4DO2-W	91
3	White	E-MW8W4DO3-W	91
4	White	E-MW8W4DO4-W	91

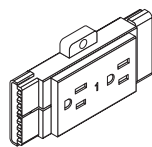

CALIFORNIA TITLE 24 CONTROLLED DUPLEX OUTLETS

Line	Color	Model Number	List
1	Black	E-MW8W4T24DO1	105
2	Black	E-MW8W4T24DO2	105
3	Black	E-MW8W4T24DO3	105
4	Black	E-MW8W4T24DO4	105
1	White	E-MW8W4T24DO1-W	105
2	White	E-MW8W4T24DO2-W	105
3	White	E-MW8W4T24DO3-W	105
4	White	E-MW8W4T24DO4-W	105

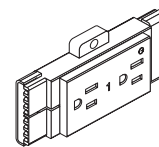

Notes

- Duplex Outlets are available at designated circuits 1 through 4.
- Each duplex outlet contains two single receptacles (places to plug into) of the same circuit and are specified separately from powerways.
- Available in black or white. The lettering on outlets for Circuit 1, 2 and 3 is white. The lettering on outlets for Circuit 4 is orange.
- Outlets are screw mounted to powerway.
- Duplex outlets are standard 15 amp outlets.
- Can be used with multi-circuit electrical units.

Notes

- In California, 50 percent of all outlets in a systems panel cluster or benching cluster, for new construction, MUST be controlled outlets, even if there is no task lighting.
- Customers should plan on using circuits 2 and 3 for controlled circuits, and plan general load for all other items on circuits 1 and 4.
- If using 2 + 2 configuration, controlled circuits should be 1 and 2, and general load circuits on 4 and 5.
- Outlets must have the "controlled" symbol for identification purposes.
- Can be used with multi-circuit electrical units.

Duplex Outlets

USB OUTLETS

Line	Color	Model Number	List
1	Black	E-UN8W4USB01	368
2	Black	E-UN8W4USB02	368
3	Black	E-UN8W4USB03	368
4	Black	E-UN8W4USB04	368
1	White	E-UN8W4USB01-W	328
2	White	E-UN8W4USB02-W	328
3	White	E-UN8W4USB03-W	328
4	White	E-UN8W4USB04-W	328

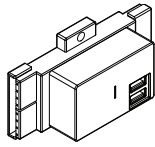

Notes

- USB Outlets bring charging options to panel power distribution systems.
- The USB Outlets provide convenient charging power access through dual ports on the face of the receptacle.
- The USB Outlets offer a total of 2 Amps between two USB charging ports.
- The USB Outlets are UL and FCC Part 15A approved.
- Can be used with multi-circuit electrical units.

DUPLEX OUTLET HOLE COVERS

Model Number	List
E-UNWC	35

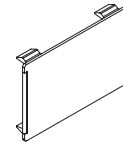

Specify

- Paint Selection for Hole Cover

Notes

- Duplex Outlet Hole Covers are supplied with each powered panel to cover unused duplex outlet locations (six).
- 24"W panels only include three duplex outlet hole covers.
- Order extra hole covers separately only when required.
- Can be used with multi-circuit electrical units.

Data Plate Kits, Data Housing Units, and Single Gang Plate Adapter

DATA PLATE KITS

Item	Model Number	List
6 Port Data Gang Plate	E-HDP6B-SM	40
Cat 5e Jack	E-HRJ45-SM	143
Cat 6 Data Jack	E-HXJ6BK-SM	156
Hole Blank (10 Pack)	E-SFBB10-SM	97

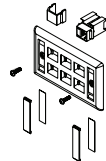

Notes

- Data Plate Kit has six ports for modular jacks.
- Bezel screws directly to the access box in pre-drilled and tapped hole pattern.
- RJ-45 jacks can be used in place of RJ-11 jacks.

SINGLE GANG PLATE ADAPTER

Model Number	List
E-DJA	56

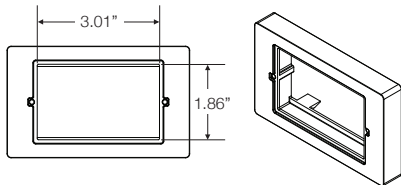

Notes

- Single Gang Plate Adapter (1) provided with each access box to adapt single gang plates to box.
- Single gang plates cannot be used with “grommet only” option.
- Available only in black.
- Knockout opening size is 3.012”W x 1.860”H.

SURFACE MOUNT DATA HOUSING UNITS

Port Quantity	Model Number	List
1	E-ISB1BK-SM	146
4	E-ISB4BK-SM	146
6	E-ISB6BK-SM	146

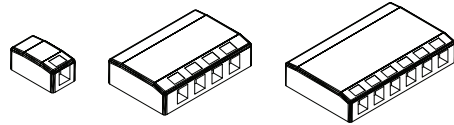

Notes

- Surface mount data housing units have a low-profile design, are ADA compliant and easily mount to multiple surfaces.
- Units include double-sided tape and mounting screws for easy installation.
- Base includes tie wrap anchors at rear cable entry point for 4” cable ties (included).
- Compatible with standard jacks.
- Port dimensions: 0.68”H x 0.58”W
- Single port housing dimensions: 1.08”H X 1.3”W X 2.38”D
- Four port housing dimensions: 1.25”H X 5”W X 3.25”D
- Six port housing dimensions: 1.25”H X 6.5”W X 4”D

Jumpers and Infeeds

ELECTRICAL JUMPERS

Actual Length	Model Number	List
18	E-MX8W4PTPC18	246
21	E-MX8W4PTPC21	258
24	E-UN8W4VT16	302
30	E-UN8W4J30	320
33	E-HM8W4PJ24	321
37	E-MW8W4PJ18	316
39	E-HM8W4PJ30	321
43	E-MW8W4PJ24	351
45	E-MW8W4PJ24E	366
48	E-UN8W4J48	320
49	E-MW8W4PJ30	376
51	E-MW8W4PJ30E	384
55	E-MW8W4PJ36	387
57	E-MW8W4PJ36E	397
61	E-MW8W4PJ42	400
63	E-MW8W4PJ42E	407
67	E-MW8W4PJ48	431
69	E-MW8W4PJ48E	442
79	E-MW8W4PJ60	464
81	E-MW8W4PJ60E	489
86	E-MW8W4PJ86	531



Oxygen Jumper Specification Grid:

Jumper length when joining powered bench top kits together

Bench Width	To 36"	To 42"	To 48"	To 54"	To 60"	To 66"	To 72"	To 78"	To 84"	To 90"	To 96"
From 36"	30	30	30	30	33	37	39	43	45	48	51
From 42"	30	33	30	33	37	39	43	45	48	51	55
From 48"	30	30	30	30	33	37	39	43	45	48	51
From 54"	30	33	30	33	37	39	43	45	48	51	55
From 60"	33	37	33	37	39	43	45	48	51	55	57
From 66"	37	39	37	39	43	45	48	51	55	57	61
From 72"	39	43	39	43	45	48	51	55	57	63	67
From 78"	43	45	43	45	48	51	55	57	61	63	67
From 84"	45	48	45	48	51	55	57	61	63	67	69
from 90"	48	51	48	51	55	57	61	63	67	69	79
From 96"	51	55	51	55	57	61	63	67	69	79	79

Notes

- Electrical jumpers are used for connecting powered bench top kits to each other in a plan.
- Electrical jumpers are listed in actual lengths to assist with specification. Jumper use is explained in the specification grid.
- **Important:** Certain areas of Chicago prohibit the use of modular electrical systems and require all electrical components to be hard wired. All electrical components need to be supplied by the electrician.

Infeeds, Power Poles and Extenders

CEILING INFEEED

Actual Length	Model Number	List
144"	E-UN8W4CIF	668

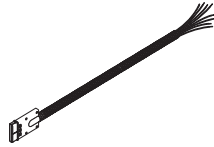

Notes

- Ceiling infeeds provide interface with building power from a suspended ceiling through a power pole shell.
- Each ceiling feed is 12' long.
- Power pole shells are ordered separately.

SIDE-MOUNTED BASE INFEEED

Actual Length	Use	Model Number	List
72"	Standard	E-UN8W4BIFS	572
72"	New York City	E-HM8W4BIFSNY	1,134

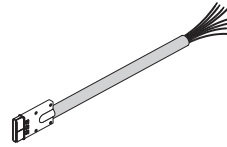

Standard Infeeds

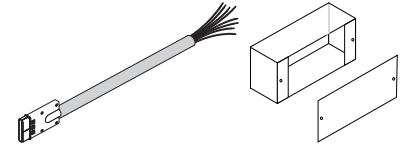

New York City Base Infeeds

Notes

- Side-mounted base infeeds provide interface with building power at the end of the power units and mounts to the powerway at jumper location.
- Each base infeed is 6' in length, encased in "liquid tight".
- New York City code requires the use of a special base feed with an in-line junction box.

POLE FOR SINGLE-SIDED BENCH

Hand	Actual Height	Model Number	List	Grade C Paint
Left Hand	136"	O-PPMSL	942	+20
Right Hand	136"	O-PPMSR	942	+20



Specify

- Paint Selection

Notes

- Power/data pole kit includes two 68" pole sections, two 68" covers, one pole coupler, two 68" dividers, mounting brackets, one ceiling shroud, one 72" perforated strip for attaching pole to ceiling grid, and mounting hardware.
- Order ceiling feeds separately.
- Designed for an 11' ceiling.

POLE FOR DOUBLE-SIDED BENCH

Actual Height	Model Number	List	Grade C Paint
136"	O-PPMD	942	+20



Specify

- Paint Selection

Notes

- Power/data pole kit includes two 68" pole sections, two 68" covers, one pole coupler, two 68" dividers, mounting brackets, one ceiling shroud, one 72" perforated strip for attaching pole to ceiling grid, and mounting hardware.
- Order ceiling feeds separately.
- Designed for an 11' ceiling.

Single Circuit Infeeds with Plug

SINGLE CIRCUIT SIDE INFEEDS WITH PLUG

Actual Length	Model Number	List
72"	E-UN8W4SIF72	1,257
120"	E-UN8W4SIF120	1,598

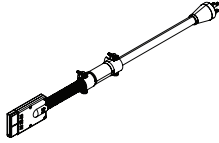
**Notes**

- Single Circuit infeeds will only provide power to line 1 outlets.
- Single Circuit Infeeds are terminated with a 20 Amp NEMA plug, a 20 Amp to 15 Amp plug adapter is included.
- Capacity for the circuit is 20 Amps, or 15 Amps if using the adapter.
- Never install more than one infeed to a circuit.

Infeeds, Power Poles and Extenders

SIDE-MOUNTED BASE INFEED WITH POLE

Actual Height	Use	Model Number	List
72"	Standard	O-8W4BIFS	1,136
72"	New York City	O-8W4BIFSNY	1,681

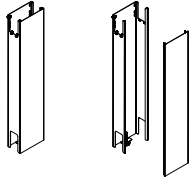

Specify

- Paint Selection

Notes

- Side-mounted base infeed with pole includes a wire management pole with the above mentioned infeed.
- Base feed is 72" long.

POWER / DATA POLE EXTENDERS

Actual Height	Model Number	List	Grade C Paint
28"	A-PPEX28	347	+10
48"	A-PPEX48	501	+10



Specify

- Paint Selection

Notes

- Power/data pole extender includes one pole section, one cover, one pole coupler and one divider.
- Order ceiling feeds separately.

VERTICAL WIRE MANAGER

Actual Height	Model Number	List
23"	O-VWM	599

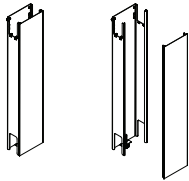

Glass 1/4" Universal Spine Insert Screens

GLASS 1/4" UNIVERSAL SPINE INSERT SCREENS						
H	W	Horizon Planning	Model Number	Clear Glass	Bronze/Gray Glass	Frosted Glass
12	36	42"H	O-3-1236	423	+ 50	+ 182
12	42	42"H	O-3-1242	457	+ 58	+ 212
12	48	42"H	O-3-1248	490	+ 66	+ 242
12	54	42"H	O-3-1254	628	+ 75	+ 273
12	60	42"H	O-3-1260	556	+ 83	+ 303
12	66	42"H	O-3-1266	588	+ 91	+ 333
12	72	42"H	O-3-1272	621	+ 99	+ 363
12	78	42"H	O-3-1278	656	+ 108	+ 394
12	84	42"H	O-3-1284	688	+ 116	+ 424
16	36	46"H	O-3-1636	628	+ 65	+ 236
16	42	46"H	O-3-1642	661	+ 76	+ 276
16	48	46"H	O-3-1648	698	+ 86	+ 316
16	54	46"H	O-3-1654	759	+ 97	+ 355
16	60	46"H	O-3-1660	810	+ 108	+ 394
16	66	46"H	O-3-1666	827	+ 119	+ 434
16	72	46"H	O-3-1672	849	+ 129	+ 473
16	78	46"H	O-3-1678	869	+ 140	+ 513
16	84	46"H	O-3-1684	888	+ 151	+ 552

GLASS 1/4" UNIVERSAL SPINE INSERT SCREENS						
H	W	Horizon Planning	Model Number	Clear Glass	Bronze/Gray Glass	Frosted Glass
20	36	50"H	O-3-2036	588	+ 80	+ 291
20	42	50"H	O-3-2042	670	+ 93	+ 340
20	48	50"H	O-3-2048	731	+ 106	+ 389
20	54	50"H	O-3-2054	791	+ 120	+ 437
20	60	50"H	O-3-2060	852	+ 133	+ 486
20	66	50"H	O-3-2066	914	+ 146	+ 535
20	72	50"H	O-3-2072	975	+ 159	+ 583
20	78	50"H	O-3-2078	1,037	+ 173	+ 632
20	84	50"H	O-3-2084	1,099	+ 186	+ 680

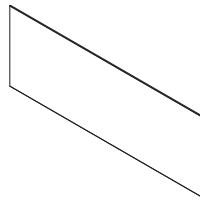

Specify

- Glass Type

Notes

- Universal Spine Insert Screens are designed to up-mount in the spine beam.
- Frosted glass is etched on one side. Patterned glass is patterned vertically as standard. Specials for horizontally patterned glass cannot be manufactured larger than 72" in width.
- Universal Spine Insert Screens can only be used on spine beam sections that are mounted to Calibrate storage elements, supported by end panels or attached to other beams sections at 90 degree or 120 degree angles.
- Universal Spine Insert Screens cannot be used on straight runs with T-feet only.

Class 3/8" Universal Spine Insert Screens

GLASS 3/8" UNIVERSAL SPINE INSERT SCREENS						
H	W	Horizon Planning	Model Number	Clear Glass	Bronze/Gray Glass	Frosted Glass
12	36	42"H	O-SGH1236	694	+ 50	+ 99
12	42	42"H	O-SGH1242	769	+ 58	+ 116
12	48	42"H	O-SGH1248	843	+ 66	+ 132
12	54	42"H	O-SGH1254	920	+ 75	+ 149
12	60	42"H	O-SGH1260	994	+ 83	+ 165
12	66	42"H	O-SGH1266	1,070	+ 91	+ 182
12	72	42"H	O-SGH1272	1,145	+ 99	+ 198
12	78	42"H	O-SGH1278	1,221	+ 108	+ 215
12	84	42"H	O-SGH1284	1,295	+ 116	+ 231
16	36	46"H	O-SGH1636	713	+ 65	+ 129
16	42	46"H	O-SGH1642	818	+ 76	+ 151
16	48	46"H	O-SGH1648	927	+ 86	+ 172
16	54	46"H	O-SGH1654	1,007	+ 97	+ 194
16	60	46"H	O-SGH1660	1,043	+ 108	+ 215
16	66	46"H	O-SGH1666	1,156	+ 119	+ 237
16	72	46"H	O-SGH1672	1,240	+ 129	+ 258
16	78	46"H	O-SGH1678	1,266	+ 140	+ 280
16	84	46"H	O-SGH1684	1,341	+ 151	+ 301

GLASS 3/8" UNIVERSAL SPINE INSERT SCREENS						
H	W	Horizon Planning	Model Number	Clear Glass	Bronze/Gray Glass	Frosted Glass
20	36	50"H	O-SGH2036	924	+ 80	+ 159
20	42	50"H	O-SGH2042	1,042	+ 93	+ 186
20	48	50"H	O-SGH2048	1,156	+ 106	+ 212
20	54	50"H	O-SGH2054	1,274	+ 120	+ 239
20	60	50"H	O-SGH2060	1,389	+ 133	+ 265
20	66	50"H	O-SGH2066	1,506	+ 146	+ 292
20	72	50"H	O-SGH2072	1,622	+ 159	+ 318
20	78	50"H	O-SGH2078	1,739	+ 173	+ 345
20	84	50"H	O-SGH2084	1,856	+ 186	+ 371
24	36	54"H	O-SGH2436	1,051	+ 95	+ 189
24	42	54"H	O-SGH2442	1,188	+ 111	+ 221
24	48	54"H	O-SGH2448	1,327	+ 126	+ 252
24	54	54"H	O-SGH2454	1,463	+ 142	+ 284
24	60	54"H	O-SGH2460	1,602	+ 158	+ 315
24	66	54"H	O-SGH2466	1,740	+ 174	+ 347
24	72	54"H	O-SGH2472	1,878	+ 189	+ 378
24	78	54"H	O-SGH2478	2,015	+ 205	+ 410
24	84	54"H	O-SGH2484	2,149	+ 221	+ 441

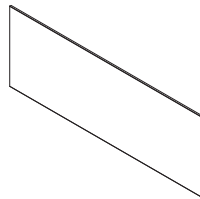

Specify	Notes
• Glass Type	<ul style="list-style-type: none"> • Universal Spine Insert Screens are designed to up-mount in the spine beam. • Frosted glass is etched on one side. Patterned glass is patterned vertically as standard. Specials for horizontally patterned glass cannot be manufactured larger than 72" in width. • Universal Spine Insert Screens can only be used on spine beam sections that are mounted to Calibrate storage elements, supported by end panels or attached to other beams sections at 90 degree or 120 degree angles. • Universal Spine Insert Screens cannot be used on straight runs with T-feet only.

PET Universal Spine Insert Screens

PET UNIVERSAL SPINE INSERT SCREENS					PET UNIVERSAL SPINE INSERT SCREENS				
H	W	Planning	Model Number	List	H	W	Planning	Model Number	List
12	36	42"H	O-5-1236	378	24	36	54"H	O-5-2436	444
12	42	42"H	O-5-1242	388	24	42	54"H	O-5-2442	467
12	48	42"H	O-5-1248	401	24	48	54"H	O-5-2448	490
12	54	42"H	O-5-1254	412	24	54	54"H	O-5-2454	511
12	60	42"H	O-5-1260	423	24	60	54"H	O-5-2460	535
12	66	42"H	O-5-1266	435	24	66	54"H	O-5-2466	556
12	72	42"H	O-5-1272	444	24	72	54"H	O-5-2472	577
12	78	42"H	O-5-1278	457	24	78	54"H	O-5-2478	600
12	84	42"H	O-5-1284	467	24	84	54"H	O-5-2484	621
16	36	46"H	O-5-1636	401	28	36	58"H	O-5-2836	467
16	42	46"H	O-5-1642	414	28	42	58"H	O-5-2842	494
16	48	46"H	O-5-1648	430	28	48	58"H	O-5-2848	519
16	54	46"H	O-5-1654	444	28	54	58"H	O-5-2854	545
16	60	46"H	O-5-1660	461	28	60	58"H	O-5-2860	572
16	66	46"H	O-5-1666	475	28	66	58"H	O-5-2866	598
16	72	46"H	O-5-1672	490	28	72	58"H	O-5-2872	621
16	78	46"H	O-5-1678	504	28	78	58"H	O-5-2878	650
16	84	46"H	O-5-1684	519	28	84	58"H	O-5-2884	674
20	36	50"H	O-5-2036	423	32	36	62"H	O-5-3236	490
20	42	50"H	O-5-2042	442	32	42	62"H	O-5-3242	519
20	48	50"H	O-5-2048	461	32	48	62"H	O-5-3248	549
20	54	50"H	O-5-2054	479	32	54	62"H	O-5-3254	577
20	60	50"H	O-5-2060	496	32	60	62"H	O-5-3260	609
20	66	50"H	O-5-2066	515	32	66	62"H	O-5-3266	637
20	72	50"H	O-5-2072	535	32	72	62"H	O-5-3272	666
20	78	50"H	O-5-2078	551	32	78	62"H	O-5-3278	697
20	84	50"H	O-5-2084	572	32	84	62"H	O-5-3284	725

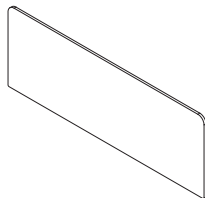

Specify

Notes

• Color Selection for PET

- Universal Spine Insert Screens are designed to up-mount in the spine beam.
- Universal Spine Insert Screens can only be used on spine beam sections that are mounted to Calibrate storage elements, supported by end panels or attached to other beams sections at 90 degree or 120 degree angles.
- Universal Spine Insert Screens cannot be used on straight runs with T-feet only.

Floor Bookcases

26" HIGH FLOOR BOOKCASES (14" DEEP)

H	W	D	Model Number	List
26	24	14	C-BC272414G	1,790
26	30	14	C-BC273014G	1,882
26	36	14	C-BC273614G	2,462
26	42	14	C-BC274214G	2,535
26	48	14	C-BC274814G	2,615
26	54	14	C-BC275414G	3,533
26	60	14	C-BC276014G	3,611
26	66	14	C-BC276614G	3,690
26	72	14	C-BC277214G	3,768

26" HIGH FLOOR BOOKCASES (18" DEEP)

H	W	D	Model Number	List
26	24	18	C-BC272418G	1,882
26	30	18	C-BC273018G	1,965
26	36	18	C-BC273618G	2,518
26	42	18	C-BC274218G	2,638
26	48	18	C-BC274818G	2,733
26	54	18	C-BC275418G	3,750
26	60	18	C-BC276018G	3,849
26	66	18	C-BC276618G	3,930
26	72	18	C-BC277218G	4,005

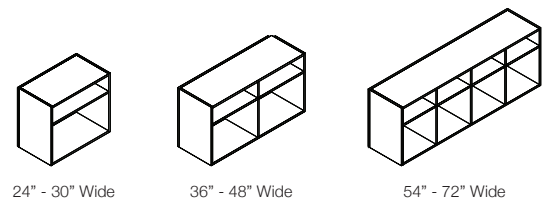
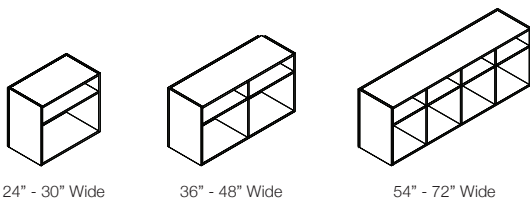

Specify

Notes

- Laminate Selection for Back and Case
- 20" H Floor Bookcases have a 3/4" laminate case construction with 1mm edgeband.
- Legs are 2 1/8" high and glides are adjustable by 1 1/2".
- 24"- 30" wide units have full open storage slots.
- 36"- 48" wide units have center upright divider creating four storage slots.
- 54"- 72" wide units have three evenly spaced upright dividers creating eight storage slots.

26" HIGH SHARED FLOOR BOOKCASES (LEFT)

H	W	D	Model Number	List
26	36	18	C-YFBCL2736G	2,490
26	42	18	C-YFBCL2742G	2,609
26	48	18	C-YFBCL2748G	2,704
26	60	18	C-YFBCL2760G	3,810
26	66	18	C-YFBCL2766G	3,893
26	72	18	C-YFBCL2772G	3,966

26" HIGH SHARED FLOOR BOOKCASES (RIGHT)

H	W	D	Model Number	List
26	36	18	C-YFBCR2736G	2,490
26	42	18	C-YFBCR2742G	2,609
26	48	18	C-YFBCR2748G	2,704
26	60	18	C-YFBCR2760G	3,810
26	66	18	C-YFBCR2766G	3,893
26	72	18	C-YFBCR2772G	3,966

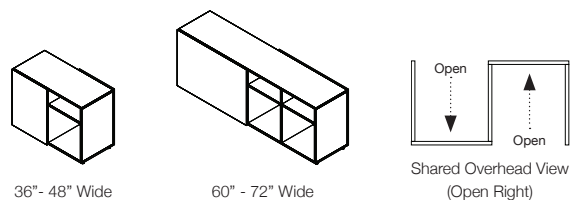
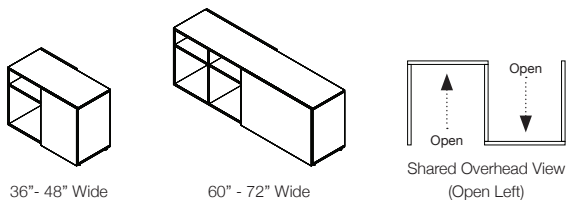

Specify

Notes

- Laminate Selection Case and Back
- 26" high shared floor bookcase has a 3/4" laminate case construction with 1mm edgeband.
- Each unit is handed to allow for left or right hand access.
- Overall unit height is 26" nominal and is available in 36" - 72" wide.
- Designed to be used adjacent to a bench.
- 26" high storage is engineered to use glides for optimal fit.

Cabinet Door and Sliding Door Credenzas

26" HIGH LAMINATE FRONT CABINET DOOR CREDENZAS

H	W	D	Model Number	List
26	24	18	C-CC272418LG	2,885
26	30	18	C-CC273018LG	3,007
26	36	18	C-CC273618LG	3,439
26	42	18	C-CC274218LG	3,557
26	48	18	C-CC274818LG	3,735
26	54	18	C-CC275418LG	5,041
26	60	18	C-CC276018LG	5,180
26	66	18	C-CC276618LG	5,278
26	72	18	C-CC277218LG	5,930

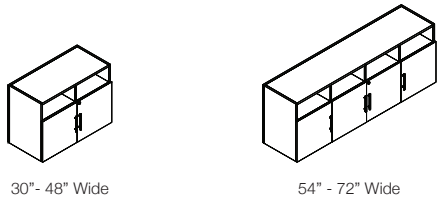

26" HIGH LAMINATE FRONT SLIDING DOOR CREDENZAS

H	W	D	Left-Handed Model Number	Right Handed Model Number	List
26	30	18	C-CS273018LLG	C-CS273018RLG	4,187
26	36	18	C-CS273618LLG	C-CS273618RLG	4,308
26	42	18	C-CS274218LLG	C-CS274218RLG	4,432
26	48	18	C-CS274818LLG	C-CS274818RLG	4,539
26	54	18	C-CS275418LLG	C-CS275418RLG	5,729
26	60	18	C-CS276018LLG	C-CS276018RLG	5,854
26	66	18	C-CS276618LLG	C-CS276618RLG	5,959
26	72	18	C-CS277218LLG	C-CS277218RLG	6,084

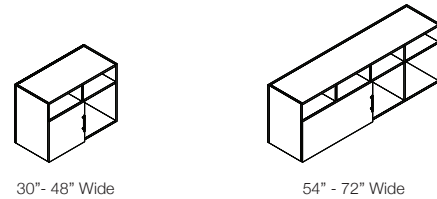

Specify	Notes
<ul style="list-style-type: none"> • Laminate Selection Case • Laminate Selection for Drawer/Face • Handle Selection • Handle Paint Selection • Lock Selection 	<ul style="list-style-type: none"> • 26"H Cabinet Door Credenzas have a 3/4" laminate case construction with 1mm edgeband. • Legs are 2 1/8"H and glides are adjustable by 1 1/2". • Cabinet doors features straight bar pull, are lockable and available in laminate or frosted acrylic. • Trim around acrylic is silver. • Only the center doors are lockable on 54" - 72" wide credenzas. • Units may be keyed alike with all AIS storage. • 24"- 48" wide units have center upright divider creating two cabinet slots. • 54"- 72" wide units have three center upright dividers creating four cabinet slots. • 26" high storage ship with glides in place of feet. • Designed to fit under bench. • Handles can be painted in any AIS Grade A, B or C color. The loop, bar, and rectangle pull are also available unpainted. Grade C paint selection incurs a \$10 upcharge. • Slim pull not available on doors. Touch-to-open handle selection incurs a \$50 upcharge per unit. • Lock cores and trim rings ship separately. • One core removal key will be included for every 25 laminate units on an order (1-25 units receive 1 core key; 25-50 units receive 2 core keys, etc.). Additional core removal keys can be purchased separately; refer to the Accessories section.

Specify	Notes
<ul style="list-style-type: none"> • Laminate Selection Case • Laminate Selection for Drawer/Face • Handle Selection • Handle Paint Selection • Lock Selection 	<ul style="list-style-type: none"> • 26"H Sliding Door Credenzas have a 3/4" laminate case construction with 1mm edgeband. • Legs are 2 1/8"H and glides are adjustable by 1 1/2". • Sliding door features straight bar pull, is lockable and available in laminate or frosted acrylic. • Trim around frosted acrylic is silver. • Sliding door is also reversible from left to right. • 30"- 48" wide units have center upright divider creating two storage slots. • 54"- 72" wide units have three evenly spaced upright dividers creating four storage slots. • Units may be keyed alike with all AIS storage. • 26" high storage is engineered to use glides for optimal fit. • Designed to sit under bench. • Handles can be painted in any AIS Grade A, B or C color. The loop, bar, and rectangle pull are also available unpainted. Grade C paint selection incurs a \$10 upcharge. • Slim pull not available on doors. Sliding door units include the option of no handle. • Lock cores and trim rings ship separately. • One core removal key will be included for every 25 laminate units on an order (1-25 units receive 1 core key; 25-50 units receive 2 core keys, etc.). Additional core removal keys can be purchased separately; refer to the Accessories section.

Shared Sliding Door Floor Bookcases

26" HIGH SHARED SLIDING DOOR FLOOR BOOKCASES (LEFT)

H	W	D	Model Number	List
26	36	18	C-YFBCSDL2736G	4,261
26	42	18	C-YFBCSDL2742G	4,389
26	48	18	C-YFBCSDL2748G	4,492
26	60	18	C-YFBCSDL2760G	5,795
26	66	18	C-YFBCSDL2766G	5,901
26	72	18	C-YFBCSDL2772G	6,021

26" HIGH SHARED SLIDING DOOR FLOOR BOOKCASES (RIGHT)

H	W	D	Model Number	List
26	36	18	C-YFBCSDR2736G	4,261
26	42	18	C-YFBCSDR2742G	4,389
26	48	18	C-YFBCSDR2748G	4,492
26	60	18	C-YFBCSDR2760G	5,795
26	66	18	C-YFBCSDR2766G	5,901
26	72	18	C-YFBCSDR2772G	6,021

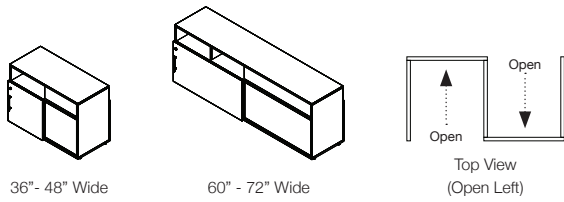

36" - 48" Wide

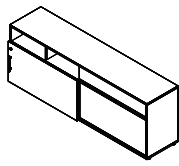

60" - 72" Wide

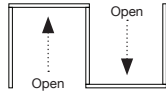

Top View
(Open Left)

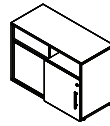

36" - 48" Wide

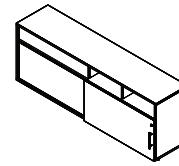

60" - 72" Wide

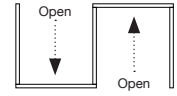

Top View
(Open Right)

Specify

Notes

- Laminate Selection for Case
- Laminate Selection for Front
- Handle Selection
- Handle Paint Selection
- Lock Selection

- 26" high shared floor bookcase with sliding door has a 3/4" laminate case construction with 1mm edgeband.
- Each unit is handed to allow for left or right hand access.
- Overall unit height is 26" nominal and is available in 36" - 72" wide.
- Designed to be used adjacent to a bench.
- Lockable.
- Comes standard with bar pulls.
- 26" high storage is engineered to use glides for optimal fit.
- Handles can be painted in any AIS Grade A, B or C color. The loop, bar and rectangle pull are also available unpainted. Grade C paint selection incurs a \$10 upcharge.
- Slim pull not available on doors. Hinged doors include the option of touch-to-open for a \$50 upcharge. Sliding doors units are available with the option of no handle.
- One core removal key will be included for every 25 laminate units on an order (1-25 units receive 1 core key; 25-50 units receive 2 core keys, etc.). Additional core removal keys can be purchased separately; refer to the Accessories section.

Single Door Cabinets

26" HIGH LAMINATE FRONT SINGLE DOOR CABINETS

H	W	D	Left-Hinge Model Number	Right-Hinge Model Number	List
26	15	18	C-SDC271518LLG	C-SDC271518RLG	2,198
26	15	24	C-SDC271524LLG	C-SDC271524RLG	2,277
26	15	30	C-SDC271530LLG	C-SDC271530RLG	2,375

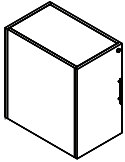

Left-Hinge

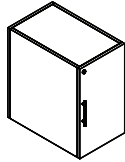

Right-Hinge

Specify	Notes
<ul style="list-style-type: none"> • Laminate Selection Case • Laminate Selection for Drawer/Face • Handle Selection • Handle Paint Selection • Lock Selection 	<ul style="list-style-type: none"> • 26"H Single Door Cabinets have a 3/4" laminate case construction with 1mm edgeband. • Legs are 2 1/8"H and glides are adjustable by 1 1/2". • Single Door Cabinets are 12" wide and are available 24", 30", or 36" deep. • Cabinet door features straight bar pull, is lockable and available in laminate or frosted acrylic. • Trim around frosted acrylic is silver. • 26" high storage ship with glides in place of feet. • Designed to sit under Bench. • Handles can be painted in any AIS Grade A, B or C color. The loop, bar, and rectangle pull are also available unpainted. Grade C paint selection incurs a \$10 upcharge. • Slim pull not available on doors. Touch-to-open handle selection incurs a \$50 upcharge per unit. • Lock cores and trim rings ship separately. • One core removal key will be included for every 25 laminate units on an order (1-25 units receive 1 core key; 25-50 units receive 2 core keys, etc.). Additional core removal keys can be purchased separately; refer to the Accessories section.

Mini Hutches and Mini Hutch Tackboards

SINGLE-SIDED MINI HUTCHES

H	W	D	Horizon Planning	Model Number	List
12	17	22.5	42"H Horizon	C-MHS1224	1,536
16	17	22.5	46"H Horizon	C-MHS1624	1,639
20	17	22.5	50"H Horizon	C-MHS2024	1,741
12	17	28.5	42"H Horizon	C-MHS1230	1,741
16	17	28.5	46"H Horizon	C-MHS1630	1,842
20	17	28.5	50"H Horizon	C-MHS2030	1,946

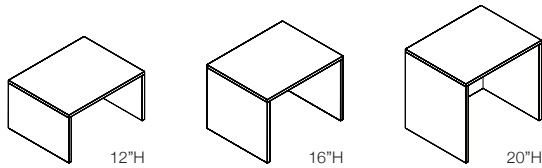

- | | |
|---|--|
| <p>Specify</p> <ul style="list-style-type: none"> • Laminate Selection for Case and Divider | <p>Notes</p> <ul style="list-style-type: none"> • Mini Hutch - Single-Sided is designed to sit on top of the surface and allow for open plan storage. • All Mini Hutch units are designed for bench depth. • Mini Hutch is used front to back on the worksurface. • Measures 17.125" wide. • Units shorter than 16"H will not accept a standing binder. • Desktop units will not mar the surface. |
|---|--|

SHARED DOUBLE-SIDED MINI HUTCHES

H	W	D	Horizon Planning	Model Number	List
12	22.5	16	42"H Horizon	C-MHD1224	1,536
16	22.5	16	46"H Horizon	C-MHD1624	1,639
20	22.5	16	50"H Horizon	C-MHD2024	1,741
12	28.5	16	42"H Horizon	C-MHD1230	1,741
16	28.5	16	46"H Horizon	C-MHD1630	1,842
20	28.5	16	50"H Horizon	C-MHD2030	1,946

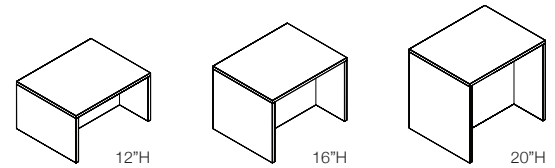

- | | |
|---|---|
| <p>Specify</p> <ul style="list-style-type: none"> • Laminate Selection for Case • Laminate Selection for Divider | <p>Notes</p> <ul style="list-style-type: none"> • Mini Hutch - Double-Sided is designed to sit on top of the surface and allow for open plan storage. • All Mini Hutch units are 16.314"D. • Mini Hutch units are sized for worksurface depth. • Units shorter than 16"H will not accept a standing binder. • Desktop units will not mar the surface. |
|---|---|

SINGLE-SIDED MINI HUTCH TACKBOARDS

H	W	For Use With	Model Number	List	Grade C Fabric	Grade D Fabric
12	22.5	C-MHS1224	C-MHTK1224	332	+19	+38
16	22.5	C-MHS1624	C-MHTK1624	370	+19	+38
20	22.5	C-MHS2024	C-MHTK2024	452	+27	+54
12	28.5	C-MHS1230	C-MHTK1230	359	+19	+38
16	28.5	C-MHS1630	C-MHTK1630	413	+19	+38
20	28.5	C-MHS2030	C-MHTK2030	499	+27	+54



- | | |
|--|---|
| <p>Specify</p> <ul style="list-style-type: none"> • Fabric Selection | <p>Notes</p> <ul style="list-style-type: none"> • Mini Hutch Single-Sided Tackboards fill the outside of a Mini Hutch to provide the user with a tackable surface. • Tackboards are sold separately. |
|--|---|

DOUBLE-SIDED MINI HUTCH TACKBOARDS

H	W	For Use With	Model Number	List	Grade C Fabric	Grade D Fabric
12	22.5	C-MHD1224	C-MHTK1224	332	+19	+38
16	22.5	C-MHD1624	C-MHTK1624	370	+19	+38
20	22.5	C-MHD2024	C-MHTK2024	452	+27	+54
12	28.5	C-MHD1230	C-MHTK1230	359	+19	+38
16	28.5	C-MHD1630	C-MHTK1630	413	+19	+38
20	28.5	C-MHD2030	C-MHTK2030	499	+27	+54



- | | |
|--|--|
| <p>Specify</p> <ul style="list-style-type: none"> • Fabric Selection | <p>Notes</p> <ul style="list-style-type: none"> • Mini Hutch - Double-Sided Tackboards fill the inside rear of a Mini Hutch - Double-Sided unit to provide the user with a tackable surface. • Tackboards are sold individually. • Units shorter than 16"H will not accept a standing binder. • Desktop units will not mar the surface. |
|--|--|

Mini Shared Shelves and Mini Shared Shelf Tackboards

HORIZONTAL DESKTOP MINI SHARED SHELF

H	W	D	Horizon Planning	Model Number	List
12	22.5	16	42"H Horizon	C-MSYYH122418	1,946
16	22.5	16	46"H Horizon	C-MSYYH162418	2,046
20	22.5	16	50"H Horizon	C-MSYYH202418	2,146
12	28.5	16	42"H Horizon	C-MSYYH123018	2,146
16	28.5	16	46"H Horizon	C-MSYYH163018	2,252
20	28.5	16	50"H Horizon	C-MSYYH203018	2,353

VERTICAL DESKTOP MINI SHARED SHELF

H	W	D	Horizon Planning	Model Number	List
12	22.5	16	42"H Horizon	C-MSYYV122418	1,946
16	22.5	16	46"H Horizon	C-MSYYV162418	2,046
20	22.5	16	50"H Horizon	C-MSYYV202418	2,146
12	28.5	16	42"H Horizon	C-MSYYV123018	2,146
16	28.5	16	46"H Horizon	C-MSYYV163018	2,252
20	28.5	16	50"H Horizon	C-MSYYV203018	2,353

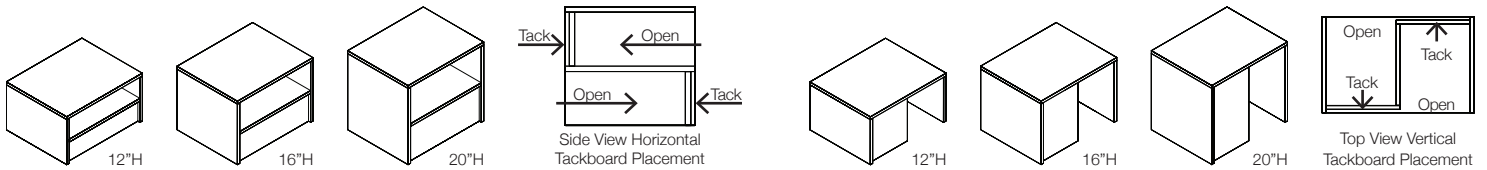

Specify

Notes

- Laminate Selection for Case
- Laminate Selection for Divider
- Mini Shared Shelves are designed to sit on top of the surface and allow for open plan storage.
- All Shared units are 16.314" deep.
- Shared are sized for worksurface depth.
- Desktop units will not mar the surface.

HORIZONTAL MINI SHARED SHELF DESKTOP TACKBOARDS

H	W	For Use With	Model Number	List	Grade C Fabric	Grade D Fabric
12	22.5	C-MSYYH122418	C-MSYYHTK122418	249	+19	+38
16	22.5	C-MSYYH162418	C-MSYYHTK162418	273	+19	+38
20	22.5	C-MSYYH202418	C-MSYYHTK202418	331	+27	+54
12	28.5	C-MSYYH123018	C-MSYYHTK123018	265	+19	+38
16	28.5	C-MSYYH163018	C-MSYYHTK163018	290	+19	+38
20	28.5	C-MSYYH203018	C-MSYYHTK203018	361	+27	+54

VERTICAL MINI SHARED SHELF DESKTOP TACKBOARDS

H	W	For Use With	Model Number	List	Grade C Fabric	Grade D Fabric
12	22.5	C-MSYYV122418	C-MSYYVTK122418	235	+19	+38
16	22.5	C-MSYYV162418	C-MSYYVTK162418	256	+19	+38
20	22.5	C-MSYYV202418	C-MSYYVTK202418	314	+27	+54
12	28.5	C-MSYYV123018	C-MSYYVTK123018	249	+19	+38
16	28.5	C-MSYYV163018	C-MSYYVTK163018	273	+19	+38
20	28.5	C-MSYYV203018	C-MSYYVTK203018	341	+27	+54

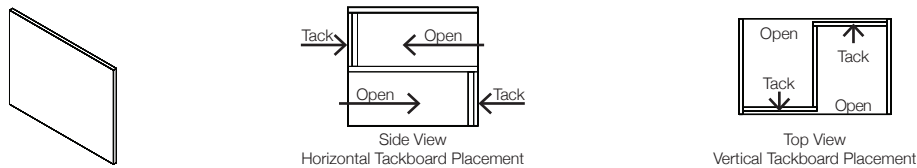

Specify

Notes

- Fabric Selection
- Mini Shared Shelf - Desktop Tackboards fill the outside rear of a Mini Shared Shelf (Horizontal) Desk Top unit to provide the user with a tackable surface.
- Tackboards are sold individually.
- Desktop units will not mar the surface.

Single-Sided Desktop Bookcases

SINGLE-SIDED DESKTOP BOOKCASE ON 4" FEET

H	W	D	Horizon Planning	Model Number	List
8	34	16	42"H Horizon	C-SSODT083616	1,682
8	40	16	42"H Horizon	C-SSODT084216	1,788
8	46	16	42"H Horizon	C-SSODT084816	1,885
8	52	16	42"H Horizon	C-SSODT085416	1,989
8	58	16	42"H Horizon	C-SSODT086016	2,089
8	64	16	42"H Horizon	C-SSODT086616	2,194
8	70	16	42"H Horizon	C-SSODT087216	2,294
12	34	16	46"H Horizon	C-SSODT123616	1,788
12	40	16	46"H Horizon	C-SSODT124216	1,885
12	46	16	46"H Horizon	C-SSODT124816	1,989
12	52	16	46"H Horizon	C-SSODT125416	2,089
12	58	16	46"H Horizon	C-SSODT126016	2,194
12	64	16	46"H Horizon	C-SSODT126616	2,294
12	70	16	46"H Horizon	C-SSODT127216	2,396
16	34	16	50"H Horizon	C-SSODT163616	1,885
16	40	16	50"H Horizon	C-SSODT164216	1,989
16	46	16	50"H Horizon	C-SSODT164816	2,089
16	52	16	50"H Horizon	C-SSODT165416	2,194
16	58	16	50"H Horizon	C-SSODT166016	2,294
16	64	16	50"H Horizon	C-SSODT166616	2,396
16	70	16	50"H Horizon	C-SSODT167216	2,499

SINGLE-SIDED DESKTOP BOOKCASE ON 8" FEET

H	W	D	Horizon Planning	Model Number	List
8	34	16	46"H Horizon	C-SSODT080836	1,681
8	40	16	46"H Horizon	C-SSODT080842	1,787
8	46	16	46"H Horizon	C-SSODT080848	1,885
8	52	16	46"H Horizon	C-SSODT080854	1,989
8	58	16	46"H Horizon	C-SSODT080860	2,089
8	64	16	46"H Horizon	C-SSODT080866	2,192
8	70	16	46"H Horizon	C-SSODT080872	2,293

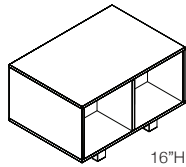
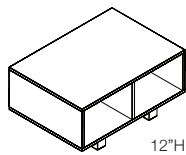
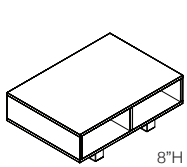
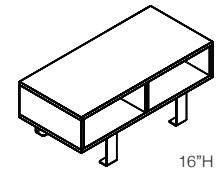

Specify

- Laminate Selection for Case and Back
- Paint Selection

Notes

- Single-Sided Desktop Bookcases are designed to sit on top of the surface and allow for open plan storage.
- Units are 2" shorter than nominal to allow for territory screens.
- Units shorter than 16"H will not accept a standing binder.
- Desktop units will not mar the surface.

Double-Sided Desktop Bookcases

DOUBLE-SIDED DESKTOP BOOKCASES ON 4" FEET

H	W	D	Horizon Planning	Model Number	List
8	34	24	42"H	C-DSODT083624	2,233
8	40	24	42"H	C-DSODT084224	2,337
8	46	24	42"H	C-DSODT084824	2,436
8	52	24	42"H	C-DSODT085424	3,008
8	58	24	42"H	C-DSODT086024	3,089
8	64	24	42"H	C-DSODT086624	3,171
8	70	24	42"H	C-DSODT087224	3,256
12	34	24	46"H	C-DSODT123624	2,294
12	40	24	46"H	C-DSODT124224	2,396
12	46	24	46"H	C-DSODT124824	2,499
12	52	24	46"H	C-DSODT125424	3,070
12	58	24	46"H	C-DSODT126024	3,151
12	64	24	46"H	C-DSODT126624	3,233
12	70	24	46"H	C-DSODT127224	3,315
16	34	24	50"H	C-DSODT163624	2,355
16	40	24	50"H	C-DSODT164224	2,460
16	46	24	50"H	C-DSODT164824	2,559
16	52	24	50"H	C-DSODT165424	3,128
16	58	24	50"H	C-DSODT166024	3,212
16	64	24	50"H	C-DSODT166624	3,293
16	70	24	50"H	C-DSODT167224	3,374

DOUBLE-SIDED DESKTOP BOOKCASES ON 8" FEET

H	W	D	Horizon Planning	Model Number	List
8	34	24	46"H	C-DSODT8083624	2,233
8	40	24	46"H	C-DSODT8084224	2,337
8	46	24	46"H	C-DSODT8084824	2,436
8	52	24	46"H	C-DSODT8085424	3,008
8	58	24	46"H	C-DSODT8086024	3,089
8	64	24	46"H	C-DSODT8086624	3,171
8	70	24	46"H	C-DSODT8087224	3,256

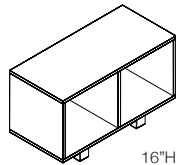
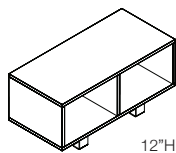
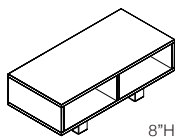
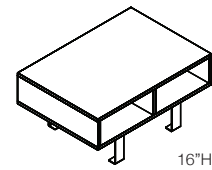

Specify

- Laminate Selection for Back
- Laminate Selection for Case
- Paint Selection

Notes

- Double-Sided Desktop Bookcases sit on feet that are 4" above the surface to provide access to the power / data along the spine beam.
- Units are designed to straddle the spine beam / worksurface seams.
- Units are 2" shorter than nominal to allow for territory screens.
- Units shorter than 16"H will not accept a standing binder.
- Desktop Units will not mar the surface.

Spine Shared Desktop Bookcases

SPINE SHARED DESKTOP BOOKCASE OPEN ON 4" FEET

H	W	D	Horizon Planning	Model Number	List	Writable Surface
8	34	16	42"H Horizon	C-YYODT083616	1,682	+181
8	40	16	42"H Horizon	C-YYODT084216	1,788	+208
8	46	16	42"H Horizon	C-YYODT084816	1,885	+234
8	52	16	42"H Horizon	C-YYODT085416	1,989	+260
8	58	16	42"H Horizon	C-YYODT086016	2,089	+287
8	64	16	42"H Horizon	C-YYODT086616	2,194	313
8	70	16	42"H Horizon	C-YYODT087216	2,294	+340
12	34	16	46"H Horizon	C-YYODT123616	1,788	+241
12	40	16	46"H Horizon	C-YYODT124216	1,885	+275
12	46	16	46"H Horizon	C-YYODT124816	1,989	+308
12	52	16	46"H Horizon	C-YYODT125416	2,089	+342
12	58	16	46"H Horizon	C-YYODT126016	2,194	+376
12	64	16	46"H Horizon	C-YYODT126616	2,294	+410
12	70	16	46"H Horizon	C-YYODT127216	2,396	+444
16	34	16	50"H Horizon	C-YYODT163616	1,885	+301
16	40	16	50"H Horizon	C-YYODT164216	1,989	+342
16	46	16	50"H Horizon	C-YYODT164816	2,089	+383
16	52	16	50"H Horizon	C-YYODT165416	2,194	+424
16	58	16	50"H Horizon	C-YYODT166016	2,294	+465
16	64	16	50"H Horizon	C-YYODT166616	2,396	+507
16	70	16	50"H Horizon	C-YYODT167216	2,499	+548

SPINE SHARED DESKTOP BOOKCASE OPEN ON 8" FEET

H	W	D	Horizon Planning	Model Number	List	Writable Surface
8	34	16	42"H Horizon	C-YYODT8083616	1681	+181
8	40	16	42"H Horizon	C-YYODT8084216	1787	+208
8	46	16	42"H Horizon	C-YYODT8084816	1885	+234
8	52	16	42"H Horizon	C-YYODT8085416	1989	+260
8	58	16	42"H Horizon	C-YYODT8086016	2089	+287
8	64	16	42"H Horizon	C-YYODT8086616	2192	313
8	70	16	42"H Horizon	C-YYODT8087216	2293	+340

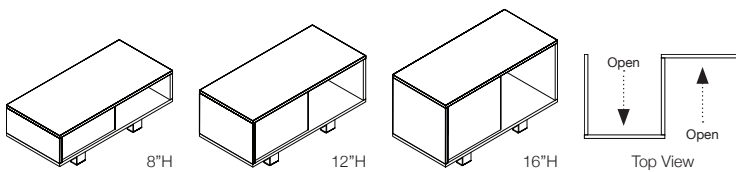
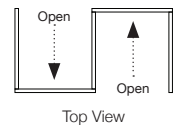
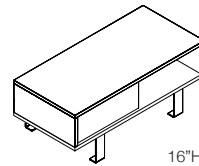

Specify

- Laminate Selection for Back
- Laminate Selection for Case
- Paint Selection
- Dry-Erase Writable Surface Option

Notes

- Spine Shared Desktop Bookcase Open sits on feet that are 4" above the surface to provide access to the power / data along the spine beam.
- Units are designed to straddle the spine beam / worksurface seams.
- Units provide shared storage.
- Units are 2" shorter than nominal to allow for territory screens.
- Units shorter than 16"H will not accept a standing binder.
- Desktop units will not mar the surface.

Single-Sided and Spine Shared Desktop Bookcase Tackboards

SINGLE-SIDED DESKTOP TACKBOARDS						
H	W	For Use With	Model Number	List	Grade C Fabric	Grade D Fabric
8	36	C-SSODT083616	C-SSODTTK083616	407	+11	+22
8	42	C-SSODT084216	C-SSODTTK084216	431	+11	+22
8	48	C-SSODT084816	C-SSODTTK084816	459	+11	+22
8	54	C-SSODT085416	C-SSODTTK085416	482	+19	+38
8	60	C-SSODT086016	C-SSODTTK086016	510	+19	+38
8	66	C-SSODT086616	C-SSODTTK086616	535	+19	+38
8	72	C-SSODT087216	C-SSODTTK087216	560	+27	+54
12	36	C-SSODT123616	C-SSODTTK123616	459	+19	+38
12	42	C-SSODT124216	C-SSODTTK124216	492	+19	+38
12	48	C-SSODT124816	C-SSODTTK124816	526	+19	+38
12	54	C-SSODT125416	C-SSODTTK125416	560	+27	+54
12	60	C-SSODT126016	C-SSODTTK126016	592	+27	+54
12	66	C-SSODT126616	C-SSODTTK126616	630	+27	+54
12	72	C-SSODT127216	C-SSODTTK127216	664	+34	+68
16	36	C-SSODT163616	C-SSODTTK163616	577	+19	+38
16	42	C-SSODT164216	C-SSODTTK164216	620	+19	+38
16	48	C-SSODT164816	C-SSODTTK164816	664	+19	+38
16	54	C-SSODT165416	C-SSODTTK165416	705	+27	+54
16	60	C-SSODT166016	C-SSODTTK166016	749	+27	+54
16	66	C-SSODT166616	C-SSODTTK166616	792	+27	+54
16	72	C-SSODT167216	C-SSODTTK167216	836	+34	+68

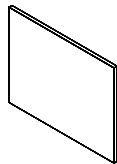

SPINE SHARED DESKTOP BOOKCASE OPEN TACKBOARDS						
H	W	For Use With	Model Number	List	Grade C Fabric	Grade D Fabric
8	36	C-YYODT083616	C-YYODTTK083616	207	+11	+22
8	42	C-YYODT084216	C-YYODTTK084216	212	+11	+22
8	48	C-YYODT084816	C-YYODTTK084816	223	+11	+22
8	54	C-YYODT085416	C-YYODTTK085416	234	+19	+38
8	60	C-YYODT086016	C-YYODTTK086016	278	+19	+38
8	66	C-YYODT086616	C-YYODTTK086616	286	+19	+38
8	72	C-YYODT087216	C-YYODTTK087216	292	+27	+54
12	36	C-YYODT123616	C-YYODTTK123616	234	+19	+38
12	42	C-YYODT124216	C-YYODTTK124216	246	+19	+38
12	48	C-YYODT124816	C-YYODTTK124816	256	+19	+38
12	54	C-YYODT125416	C-YYODTTK125416	273	+27	+54
12	60	C-YYODT126016	C-YYODTTK126016	320	+27	+54
12	66	C-YYODT126616	C-YYODTTK126616	331	+27	+54
12	72	C-YYODT127216	C-YYODTTK127216	347	+34	+68
16	36	C-YYODT163616	C-YYODTTK163616	278	+19	+38
16	42	C-YYODT164216	C-YYODTTK164216	278	+19	+38
16	48	C-YYODT164816	C-YYODTTK164816	312	+19	+38
16	54	C-YYODT165416	C-YYODTTK165416	328	+27	+54
16	60	C-YYODT166016	C-YYODTTK166016	400	+27	+54
16	66	C-YYODT166616	C-YYODTTK166616	416	+27	+54
16	72	C-YYODT167216	C-YYODTTK167216	431	+34	+68

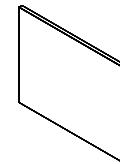

Specify

- Fabric Selection

Notes

- Single-Sided Desktop Tackboards fill the unused side of a Single-Sided Overhead - Desktop, providing the user with a tackable surface.
- Tackboards are sold individually.

Specify

- Fabric Selection

Notes

- Spine Shared Desktop Bookcase Open Tackboards fill the unused side of an Shared Overhead Desk Top to provide the user with a tackable surface.
- Tackboards are sold individually.

Shared Overheads and Bench End Worksurfaces

SHARED OVERHEADS WITH SLIDING DOORS

H	W	D	Horizon Planning	Model Number	List	Writable Surface
16	34	16	50"H Horizon	C-SOSDDT163615	3,520	+301
16	46	16	50"H Horizon	C-SOSDDT164215	3,620	+342
16	46	16	50"H Horizon	C-SOSDDT164815	3,724	+383
16	52	16	50"H Horizon	C-SOSDDT165415	3,824	+424
16	58	16	50"H Horizon	C-SOSDDT166015	3,927	+465
16	64	16	50"H Horizon	C-SOSDDT166615	4,028	+507
16	70	16	50"H Horizon	C-SOSDDT167215	4,131	+548

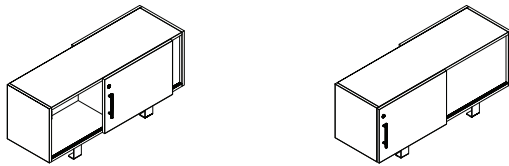

BENCH END WORKSURFACES

W	D	Model Number	List
48	16	C-EBWS1648	515
60	16	C-EBWS1660	582
48	18	C-EBWS1848	549
60	18	C-EBWS1860	619
48	20	C-EBWS2048	582
60	20	C-EBWS2060	659

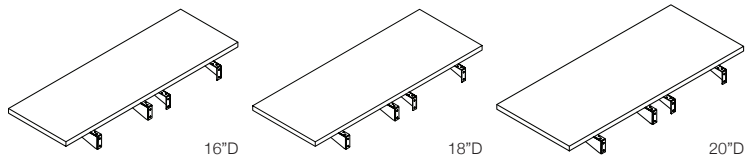

Specify	Notes
<ul style="list-style-type: none"> • Laminate Selection for Back • Laminate Selection for Case • Laminate Selection for Front • Handle Selection • Handle Paint Selection • Lock Selection 	<ul style="list-style-type: none"> • Shared Overheads with Sliding Doors sit on feet that are 4" above the surface to provide access to the power / data along the spine beam. • Units are designed to straddle the spine beam / worksurface seams. • Lockable. • Units are 2" shorter than nominal to allow for territory screens. • Units can be ordered with a glass writing surface over white or any standard laminate. • Comes standard with bar pulls. • Desktop units will not mar the surface. • Handles can be painted in any AIS Grade A, B or C color. The loop, bar, and rectangle pull are also available unpainted. Grade C paint selection incurs a \$10 upcharge. • Slim pull not available on doors. Sliding door units include the option of no handle. • Lock cores and trim rings ship separately. • One core removal key will be included for every 25 laminate units on an order (1-25 units receive 1 core key; 25-50 units receive 2 core keys, etc.). Additional core removal keys can be purchased separately; refer to the Accessories section.

Specify	Notes
<ul style="list-style-type: none"> • Laminate Selection • Paint Selection • Edge Selection 	<ul style="list-style-type: none"> • Bench End Worksurfaces mount to the end-of-run legs with cantilevers. • Bench End Worksurfaces must be used on a bench that is at least 48" wide, or any combination of two benches or more. • Weight capacity is 150lbs.

Metal Freestanding Pedestals

26" HIGH FREESTANDING BOX / BOX / FILE PEDESTAL

H	Model Number	List	Paint Grade C
26	S-PEDBBFJ24G	1,241	+118

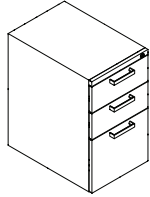

26" HIGH FREESTANDING FILE / FILE PEDESTAL

H	Model Number	List	Paint Grade C
26	S-PEDFFJ24G	1,241	+118

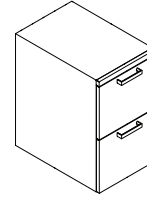

Specify

Notes

- Paint Selection

- 26"H L Series Metal Pedestals have a square front with brushed nickel rectangle pulls.
- Box drawers and file drawers have full depth, smooth riding ball bearing suspensions.
- All pedestals are lockable with two supplied LL keys.
- Pedestals come equipped for front-to-back letter-size filing.
- Box / box / file pedestals include one box drawer pencil tray.
- 20" - 26"H pedestals may be used under bench tops.

Freestanding Laminate Pedestals

26" HIGH LAMINATE BOX / BOX / FILE PEDESTAL (FREESTANDING)

H	W	D	Model Number	List
26	16.5	24	C-BBFPFS24G	3,136

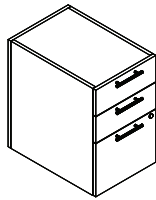

26" HIGH LAMINATE FILE / FILE PEDESTAL (FREESTANDING)

H	W	D	Model Number	List
26	16.5	24	C-FFPFS24G	3,086

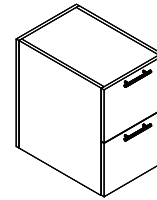

Specify

Notes

- Laminate selection for Case
- Laminate selection for Drawer/Front
- Paint Selection
- Handle selection
- Handle paint selection
- Lock selection

- 26"H Laminate Pedestals have a 3/4" laminate case construction with 1mm edgeband.
- Box drawers and file drawers have full depth, smooth riding ball bearing suspensions.
- All pedestals are lockable with two supplied keys.
- Comes standard with bar pulls.
- 26"H storage is engineered to use glides for optimal fit.
- Designed to sit under Bench.
- 26"H Laminate Pedestals cannot be used on benches with same depth as the pedestal. Pedestal must be 6" smaller.
Ex: 24" deep pedestal can be used with 30" bench. 18" deep pedestal can be used with 24" bench.
- Handles can be painted in any AIS Grade A, B, or C color. The loop, bar and rectangle pull are also available unpainted. Grade C Paint selection incurs a \$10 upcharge.
- Slim pull incurs a \$75 upcharge.
- Lock cores and trim rings ship separately.
- One core removal key will be included for every 25 laminate units on an order (1-25 units receive 1 core key; 25-50 units receive 2 core keys, etc.) Additional core removal keys can be purchased separately. Refer to the Accessories section.

26" HIGH LAMINATE FILE / FILE LATERAL FILES (FREESTANDING)

H	W	D	Model Number	List
26	30	18	C-LAT2D1830G	3,829
26	36	18	C-LAT2D1836G	3,930
26	42	18	C-LAT2D1842G	4,127
26	30	24	C-LAT2D2430G	4,367
26	36	24	C-LAT2D2436G	4,519
26	42	24	C-LAT2D2442G	4,827

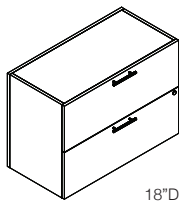

18"D

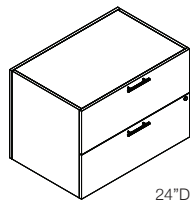

24"D

Specify

Notes

- Laminate Selection Case
 - Laminate Selection for Drawer/Front
 - Handle Selection
 - Handle Paint Selection
 - Lock Selection
- 26"H Laminate Lateral Files have a 3/4" laminate case construction with 1mm edgeband.
 - Overall unit height is 26" nominal and is available in 30" - 42" wide.
 - 18" deep units provide letter filing both vertically and front to back, but legal filing front to back only.
 - 24" deep units provide letter and legal filing both laterally and front to back.
 - Comes standard with bar pulls.
 - 26"H storage is engineered to use glides for optimal fit.
 - Designed to sit under Bench.
 - Handles can be painted in any AIS Grade A, B or C color. The loop, bar, and rectangle pull are also available unpainted. Grade C paint selection incurs a \$10 upcharge.
 - Slim pull not available on doors. Sliding door units include the option of no handle.
 - Slim pull incurs a \$75 upcharge.
 - Lock cores and trim rings ship separately.
 - One core removal key will be included for every 25 laminate units on an order (1-25 units receive 1 core key; 25-50 units receive 2 core keys, etc.). Additional core removal keys can be purchased separately; refer to the Accessories section.

Pebble Tables with Slim Post Legs

2MM EDGE PEBBLE TABLES WITH SLIM POST LEGS						
D	W	H	On Glides		On Casters	
			Model Number	List	Model Number	List
30	36	29	T-PBR303629SMG	2,814	T-PBR303629SMC	2,808
30	42	29	T-PBR304229SMG	2,848	T-PBR304229SMC	2,842
30	48	29	T-PBR304829SMG	2,885	T-PBR304829SMC	2,878
30	54	29	T-PBR305429SMG	3,018	T-PBR305429SMC	3,010
30	60	29	T-PBR306029SMG	3,068	T-PBR306029SMC	3,061
30	66	29	T-PBR306629SMG	3,185	T-PBR306629SMC	3,178
30	72	29	T-PBR307229SMG	3,249	T-PBR307229SMC	3,242
36	42	29	T-PBR364229SMG	2,897	T-PBR364229SMC	2,892
36	48	29	T-PBR364829SMG	2,941	T-PBR364829SMC	2,933
36	54	29	T-PBR365429SMG	3,081	T-PBR365429SMC	3,074
36	60	29	T-PBR366029SMG	3,137	T-PBR366029SMC	3,129
36	66	29	T-PBR366629SMG	3,263	T-PBR366629SMC	3,258
36	72	29	T-PBR367229SMG	3,333	T-PBR367229SMC	3,327
42	48	29	T-PBR424829SMG	2,996	T-PBR424829SMC	2,989
42	54	29	T-PBR425429SMG	3,145	T-PBR425429SMC	3,137
42	60	29	T-PBR426029SMG	3,207	T-PBR426029SMC	3,202
42	66	29	T-PBR426629SMG	3,340	T-PBR426629SMC	3,333
42	72	29	T-PBR427229SMG	3,419	T-PBR427229SMC	3,411
48	54	29	T-PBR485429SMG	3,207	T-PBR485429SMC	3,202
48	60	29	T-PBR486029SMG	3,277	T-PBR486029SMC	3,271
48	66	29	T-PBR486629SMG	3,419	T-PBR486629SMC	3,411
48	72	29	T-PBR487229SMG	3,503	T-PBR487229SMC	3,495

KNIFE EDGE PEBBLE TABLES WITH SLIM POST LEGS						
D	W	H	On Glides		On Casters	
			Model Number	List	Model Number	List
30	36	29	T-PBK303629SMG	4,235	T-PBK303629SMC	4,225
30	42	29	T-PBK304229SMG	4,291	T-PBK304229SMC	4,288
30	48	29	T-PBK304829SMG	4,353	T-PBK304829SMC	4,349
30	54	29	T-PBK305429SMG	4,502	T-PBK305429SMC	4,492
30	60	29	T-PBK306029SMG	4,573	T-PBK306029SMC	4,566
30	66	29	T-PBK306629SMG	4,705	T-PBK306629SMC	4,700
30	72	29	T-PBK307229SMG	4,791	T-PBK307229SMC	4,783
36	42	29	T-PBK364229SMG	4,378	T-PBK364229SMC	4,371
36	48	29	T-PBK364829SMG	4,449	T-PBK364829SMC	4,445
36	54	29	T-PBK365429SMG	4,608	T-PBK365429SMC	4,603
36	60	29	T-PBK366029SMG	4,693	T-PBK366029SMC	4,687
36	66	29	T-PBK366629SMG	4,839	T-PBK366629SMC	4,832
36	72	29	T-PBK367229SMG	4,935	T-PBK367229SMC	4,929
42	48	29	T-PBK424829SMG	4,548	T-PBK424829SMC	4,542
42	54	29	T-PBK425429SMG	4,716	T-PBK425429SMC	4,711
42	60	29	T-PBK426029SMG	4,814	T-PBK426029SMC	4,808
42	66	29	T-PBK426629SMG	4,972	T-PBK426629SMC	4,966
42	72	29	T-PBK427229SMG	5,083	T-PBK427229SMC	5,072
48	54	29	T-PBK485429SMG	4,826	T-PBK485429SMC	4,821
48	60	29	T-PBK486029SMG	4,935	T-PBK486029SMC	4,929
48	66	29	T-PBK486629SMG	5,105	T-PBK486629SMC	5,099
48	72	29	T-PBK487229SMG	5,227	T-PBK487229SMC	5,222



Specify

Notes

- Laminate Selection for Worksurface
- Color Selection for Edge
- Color Selection for Leg - Painted or Bright Metal

Corner Left Tables with Slim Post Legs

2MM EDGE CORNER LEFT TABLES WITH SLIM POST LEGS						
D	W	H	On Glides		On Casters	
			Model Number	List	Model Number	List
24	42x60	29	T-CLR244260SMG	3,801	T-CLR244260SMC	3,792
24	42x66	29	T-CLR244266SMG	3,865	T-CLR244266SMC	3,856
24	42x72	29	T-CLR244272SMG	3,927	T-CLR244272SMC	3,918
24	48x60	29	T-CLR244860SMG	3,872	T-CLR244860SMC	3,864
24	48x66	29	T-CLR244866SMG	3,941	T-CLR244866SMC	3,934
24	48x72	29	T-CLR244872SMG	4,014	T-CLR244872SMC	4,004
30	42x60	29	T-CLR304260SMG	3,801	T-CLR304260SMC	3,792
30	42x66	29	T-CLR304266SMG	3,865	T-CLR304266SMC	3,856
30	42x72	29	T-CLR304272SMG	3,927	T-CLR304272SMC	3,918
30	48x60	29	T-CLR304860SMG	3,872	T-CLR304860SMC	3,864
30	48x66	29	T-CLR304866SMG	3,941	T-CLR304866SMC	3,934
30	48x72	29	T-CLR304872SMG	4,014	T-CLR304872SMC	4,004

KNIFE EDGE CORNER LEFT TABLES WITH SLIM POST LEGS						
D	W	H	On Glides		On Casters	
			Model Number	List	Model Number	List
24	42x60	29	T-CLK244260SMG	5,326	T-CLK244260SMC	5,318
24	42x66	29	T-CLK244266SMG	5,423	T-CLK244266SMC	5,413
24	42x72	29	T-CLK244272SMG	5,521	T-CLK244272SMC	5,510
24	48x60	29	T-CLK244860SMG	5,447	T-CLK244860SMC	5,440
24	48x66	29	T-CLK244866SMG	5,555	T-CLK244866SMC	5,550
24	48x72	29	T-CLK244872SMG	5,666	T-CLK244872SMC	5,659
30	42x60	29	T-CLK304260SMG	5,326	T-CLK304260SMC	5,318
30	42x66	29	T-CLK304266SMG	5,423	T-CLK304266SMC	5,413
30	42x72	29	T-CLK304272SMG	5,521	T-CLK304272SMC	5,510
30	48x60	29	T-CLK304860SMG	5,447	T-CLK304860SMC	5,440
30	48x66	29	T-CLK304866SMG	5,555	T-CLK304866SMC	5,550
30	48x72	29	T-CLK304872SMG	5,666	T-CLK304872SMC	5,659

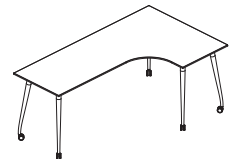
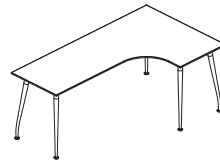
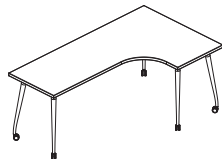
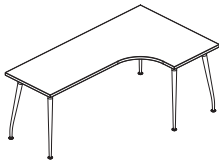

Specify

Notes

- Laminate Selection for Worksurface
- Color Selection for Edge
- Color Selection for Leg - Painted or Bright Metal

Corner Right Tables with Slim Post Legs

2MM EDGE CORNER RIGHT TABLES WITH SLIM POST LEGS						
D	W	H	On Glides		On Casters	
			Model Number	List	Model Number	List
24	42x60	29	T-CRR244260SMG	3,801	T-CRR244260SMC	3,792
24	42x66	29	T-CRR244266SMG	3,865	T-CRR244266SMC	3,856
24	42x72	29	T-CRR244272SMG	3,927	T-CRR244272SMC	3,918
24	48x60	29	T-CRR244860SMG	3,872	T-CRR244860SMC	3,864
24	48x66	29	T-CRR244866SMG	3,941	T-CRR244866SMC	3,934
24	48x72	29	T-CRR244872SMG	4,014	T-CRR244872SMC	4,004
30	42x60	29	T-CRR304260SMG	3,801	T-CRR304260SMC	3,792
30	42x66	29	T-CRR304266SMG	3,865	T-CRR304266SMC	3,856
30	42x72	29	T-CRR304272SMG	3,927	T-CRR304272SMC	3,918
30	48x60	29	T-CRR304860SMG	3,872	T-CRR304860SMC	3,864
30	48x66	29	T-CRR304866SMG	3,941	T-CRR304866SMC	3,934
30	48x72	29	T-CRR304872SMG	4,014	T-CRR304872SMC	4,004

KNIFE EDGE CORNER RIGHT TABLES WITH SLIM POST LEGS						
D	W	H	On Glides		On Casters	
			Model Number	List	Model Number	List
24	42x60	29	T-CRK244260SMG	5,326	T-CRK244260SMC	5,318
24	42x66	29	T-CRK244266SMG	5,423	T-CRK244266SMC	5,413
24	42x72	29	T-CRK244272SMG	5,521	T-CRK244272SMC	5,510
24	48x60	29	T-CRK244860SMG	5,447	T-CRK244860SMC	5,440
24	48x66	29	T-CRK244866SMG	5,555	T-CRK244866SMC	5,550
24	48x72	29	T-CRK244872SMG	5,666	T-CRK244872SMC	5,659
30	42x60	29	T-CRK304260SMG	5,326	T-CRK304260SMC	5,318
30	42x66	29	T-CRK304266SMG	5,423	T-CRK304266SMC	5,413
30	42x72	29	T-CRK304272SMG	5,521	T-CRK304272SMC	5,510
30	48x60	29	T-CRK304860SMG	5,447	T-CRK304860SMC	5,440
30	48x66	29	T-CRK304866SMG	5,555	T-CRK304866SMC	5,550
30	48x72	29	T-CRK304872SMG	5,666	T-CRK304872SMC	5,659

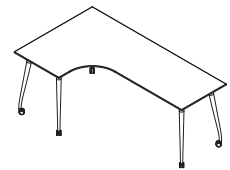
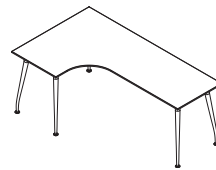
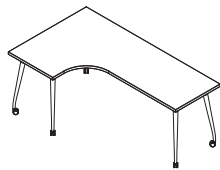
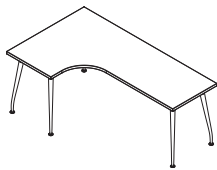

Specify

Notes

- Laminate Selection for Worksurface
- Color Selection for Edge
- Color Selection for Leg - Painted or Bright Metal

120° Corner and 60° Trapezoid with Slim Post Legs

2MM EDGE 120° CORNER TABLES WITH SLIM POST LEGS

D	W	H	On Glides		On Casters	
			Model Number	List	Model Number	List
24	54x54	29	T-YR245454TPG	4,223	T-YR245454TPC	4,214
30	54x54	29	T-YR305454TPG	4,317	T-YR305454TPC	4,312

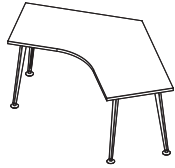

KNIFE EDGE 120° CORNER TABLES WITH SLIM POST LEGS

D	W	H	On Glides		On Casters	
			Model Number	List	Model Number	List
24	54x54	29	T-YK245454TPG	6,018	T-YK245454TPC	6,012
30	54x54	29	T-YK305454TPG	6,181	T-YK305454TPC	6,174

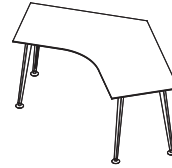

Specify **Notes**

- Laminate Selection for Worksurface
- Color Selection for Edge
- Color Selection for Leg - Painted or Bright Metal

2MM EDGE 60° TRAPEZOID TABLES WITH SLIM POST LEGS

D	W	H	On Glides		On Casters	
			Model Number	List	Model Number	List
24	60	29	T-TZR246029SMG	2972	T-TZR246029SMC	2961
24	66	29	T-TZR246629SMG	2996	T-TZR246629SMC	2989
24	72	29	T-TZR247229SMG	3054	T-TZR247229SMC	3044
24	78	29	T-TZR247829SMG	3,081	T-TZR247829SMC	3,074
24	84	29	T-TZR248429SMG	3,137	T-TZR248429SMC	3,129
30	66	29	T-TZR306629SMG	3,074	T-TZR306629SMC	3,068
30	72	29	T-TZR307229SMG	3,137	T-TZR307229SMC	3,129
30	78	29	T-TZR307829SMG	3,175	T-TZR307829SMC	3,165
30	84	29	T-TZR308429SMG	3,234	T-TZR308429SMC	3,231



Specify **Notes**

- Laminate Selection for Worksurface
- Color Selection for Edge
- Color Selection for Leg - Painted or Bright Metal

Round and Triangle Tables with Slim Post Legs

2MM EDGE ROUND TABLES ON SLIM POST LEGS

D	H	On Glides		On Casters	
		Model Number	List	Model Number	List
24	29	T-RDR2429SMG	2,717	T-RDR2429SMC	2,709
30	29	T-RDR3029SMG	2,778	T-RDR3029SMC	2,773
36	29	T-RDR3629SMG	2,858	T-RDR3629SMC	2,848
42	29	T-RDR4229SMG	2,949	T-RDR4229SMC	2,941
48	29	T-RDR4829SMG	3,054	T-RDR4829SMC	3,044
54	29	T-RDR5429SMG	3,340	T-RDR5429SMC	3,333
60	29	T-RDR6029SMG	3,503	T-RDR6029SMC	3,495

KNIFE EDGE ROUND TABLES ON SLIM POST LEGS

D	H	On Glides		On Casters	
		Model Number	List	Model Number	List
24	29	T-RDK2429SMG	4,063	T-RDK2429SMC	4,058
30	29	T-RDK3029SMG	4,169	T-RDK3029SMC	4,166
36	29	T-RDK3629SMG	4,305	T-RDK3629SMC	4,298
42	29	T-RDK4229SMG	4,463	T-RDK4229SMC	4,459
48	29	T-RDK4829SMG	4,647	T-RDK4829SMC	4,638
54	29	T-RDK5429SMG	4,995	T-RDK5429SMC	4,992
60	29	T-RDK6029SMG	5,251	T-RDK6029SMC	5,242

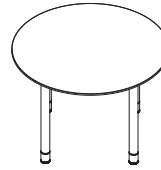

2MM EDGE TRIANGLE TABLES ON SLIM POST LEGS

D	H	On Glides		On Casters	
		Model Number	List	Model Number	List
36	29	T-TRR3629SMG	2,842	T-TRR3629SMC	2,835
48	29	T-TRR4829SMG	3,037	T-TRR4829SMC	3,033
54	29	T-TRR5429SMG	3,159	T-TRR5429SMC	3,150
60	29	T-TRR6029SMG	3,291	T-TRR6029SMC	3,286

KNIFE EDGE TRIANGLE TABLES ON SLIM POST LEGS

D	H	On Glides		On Casters	
		Model Number	List	Model Number	List
36	29	T-TRK3629SMG	4,291	T-TRK3629SMC	4,288
48	29	T-TRK4829SMG	4,632	T-TRK4829SMC	4,627
54	29	T-TRK5429SMG	4,839	T-TRK5429SMC	4,832
60	29	T-TRK6029SMG	5,067	T-TRK6029SMC	5,064

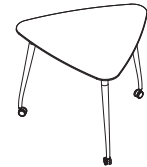

Specify

Notes

- Laminate Selection for Worksurface
- Color Selection for Edge
- Color Selection for Leg - Painted or Bright Metal

Tool Rails and Bench End Worksurfaces

FRONT-TO-BACK TOOL BARS (LEFT)

W	Model Number	List	Paint Grade C
22.5	O-TBFTBL24	577	+25
28.5	O-TBFTBL30	633	+25

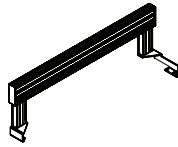

FRONT-TO-BACK TOOL BARS (RIGHT)

W	Model Number	List	Paint Grade C
22.5	O-TBFTBR24	577	+25
28.5	O-TBFTBR30	633	+25

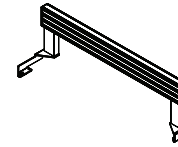

FRONT-TO-BACK TOOL BARS (SHARED)

W	Model Number	List	Paint Grade C
22.5	O-TBFTBC24	596	+25
28.5	O-TBFTBC30	653	+25

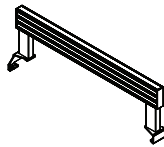

Specify

Notes

- Paint Selection

- Front-to-back tool rails are mounted directly to a worksurface to allow for the use of tool bar accessories.
- Tool bars are double-sided to allow for accessories to be mounted to either side.

WORKSURFACE REAR-MOUNTED TOOL RAIL

W	Model Number	List	Paint Grade C
24	A-WSMTR24	465	+25
30	A-WSMTR30	499	+25
36	A-WSMTR36	534	+25
42	A-WSMTR42	567	+25
48	A-WSMTR48	599	+25
54	A-WSMTR54	633	+25
60	A-WSMTR60	666	+25
66	A-WSMTR66	839	+25
72	A-WSMTR72	874	+25

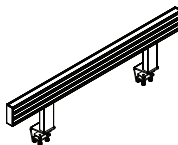

Specify

Notes

- Paint Selection

- Worksurface rear mounted tool rail mounts directly to a worksurface, and does not require panels for support.
- Rail is clamped onto the surface using supplied hardware.
- Worksurface mounted tool rails are double-sided, allowing for accessories to be mounted to either side.
- 66" and 72" wide rails come with three sets of mounting hardware.

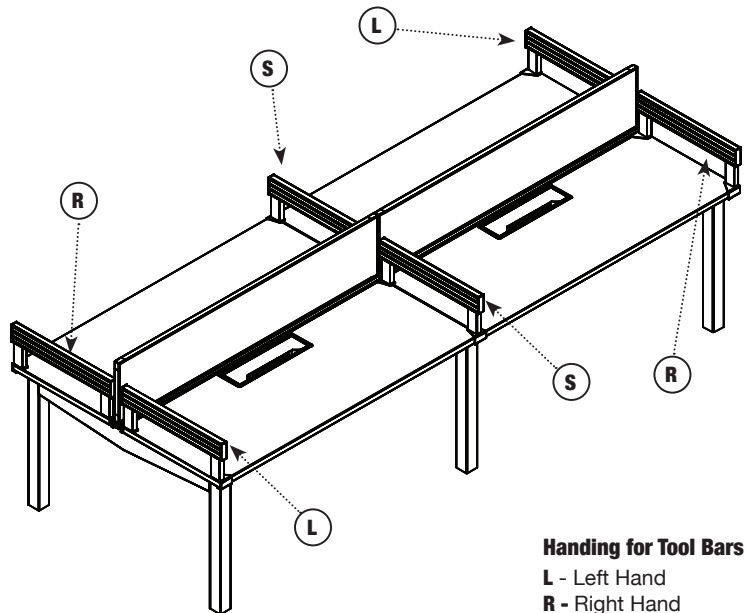

Handing for Tool Bars

- L** - Left Hand
- R** - Right Hand
- S** - Shared

Tool Bar Accessories and Spin-Out Pencil Drawers

STANDARD TOOL BAR ACCESSORIES

Type	Model Number	List
Portrait Paper Tray	P-MXTBPT	161
Landscape Paper Tray	P-MXTBLPT	161
Diagonal Folder Sorter	P-MXTBDFS	183
Pencil Holder	P-MXTBPENH	67
Accessories Tray	P-MXTBAT	121

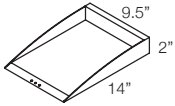

Portrait Paper Tray

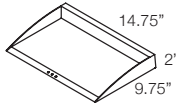

Landscape Paper Tray

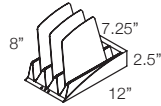

Diagonal Folder Sorter

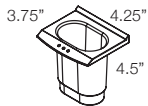

Pencil Holder

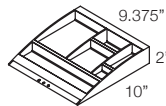

Accessories Tray

Specify

- Black or Clear Plastic Selection

Notes

- Standard tool bar accessories can be universally used on all AIS tool rails except Calibrate tackboards with tool rails.
- Available in black or clear.

SPIN-OUT PENCIL DRAWERS

W	D	Type	Model Number	List
7 1/2	7 1/2	Radius Jr.	A-ROKJ	214
13 5/8	8 1/4	Radius	A-ROK	243



Radius Jr.

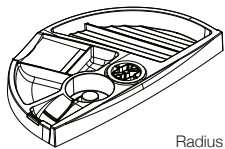

Radius

Notes

- Spin out pencil drawers provide convenient, low profile storage of loose items.
- Plan organizer kit placement around worksurface support elements.
- Available in black only.

METAL TOOL BAR ACCESSORIES

Type	Model Number	List	Paint Grade C
Portrait Paper Tray	A-TBPPT	174	+10
Landscape Paper Tray	A-TBLPT	174	+10
Diagonal Folder Holder	A-TBDFS	180	+10
Binder Holder	A-TBBH	174	+10
Pencil Holder	A-TBPT	123	+10
Folder Box	A-TBFH	161	+10
18" Mini Shelf	P-MXTBMESH18	286	+10
24" Mini Shelf	P-MXTBMESH24	386	+10
30" Mini Shelf	P-MXTBMESH30	401	+10
36" Mini Shelf	P-MXTBMESH36	459	+10



Portrait Paper Tray

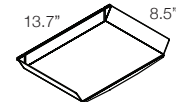

Landscape Paper Tray



Diagonal Folder Holder

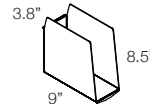

Binder Holder



Pencil Tray

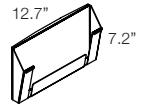

Folder Box

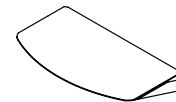

Mini Shelf

Specify

- Paint Selection

Notes

- Metal tool bar accessories can be universally used on all AIS tool rails except Calibrate tackboards with tool rails.
- Available painted in any AIS paint color.

Credenza Cushions

CREDENZA CUSHIONS

D	W	Model Number	List	Upholstery Grade B	Upholstery Grade C	Upholstery Grade D	Upholstery Grade E
18	18	S-BCUSH1818	596	+51	+102	+152	+203
18	21	S-BCUSH1821	618	+51	+102	+152	+203
18	24	S-BCUSH1824	643	+51	+102	+152	+203
18	27	S-BCUSH1827	668	+51	+102	+152	+203
18	30	S-BCUSH1830	695	+62	+124	+186	+248
18	33	S-BCUSH1833	723	+62	+124	+186	+248
18	36	S-BCUSH1836	752	+62	+124	+186	+248
18	42	S-BCUSH1842	782	+73	+146	+208	+270
18	48	S-BCUSH1848	813	+73	+146	+208	+270
18	54	S-BCUSH1854	845	+73	+146	+208	+270
18	60	S-BCUSH1860	879	+95	+160	+228	+298
18	66	S-BCUSH1866	915	+95	+160	+228	+298
18	72	S-BCUSH1872	951	+95	+160	+228	+298

SHARED CREDENZA CUSHIONS

D	W	Model Number	List	Upholstery Grade C	Upholstery Grade D	Upholstery Grade E
36	30	S-BCUSH3630	1,188	+95	+160	+228
36	36	S-BCUSH3636	1,307	+95	+160	+228
36	42	S-BCUSH3642	1,437	+95	+160	+228

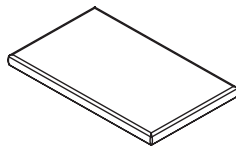
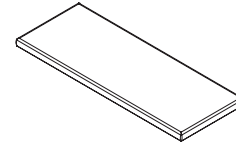

Specify

- Upholstery Selection

Notes

- Credenza cushions are a fabric covered 1” thick foam cushion.
- Cushions include Velcro for mounting.

Lock Cores and Replacement Pulls

SILVER LOCK CORES AND KEYS

Key Type	Model Number	List
Core with 2 keys	S-W1CORE1	24
Core with 2 keys (set of 2 keyed alike)	S-W1CORE2	37
Core with 2 keys (set of 3 keyed alike)	S-W1CORE3	58
Core with 2 keys (set of 4 keyed alike)	S-W1CORE4	74
Core with 2 keys (set of 5 keyed alike)	S-W1CORE5	92
Core with 2 keys (set of 6 keyed alike)	S-W1CORE6	107
Core with 2 keys (set of 7 keyed alike)	S-W1CORE7	125
Core with 2 keys (set of 8 keyed alike)	S-W1CORE8	144
Core with 2 keys (set of 9 keyed alike)	S-W1CORE9	161
Core with 2 keys (set of 10 keyed alike)	S-W1CORE10	178
Master Key	RS-W1MKEY	18
Core Removal Key	RS-W1CRKEY	18
Replacement Key	RS-WK __ _ (Key Number)	25

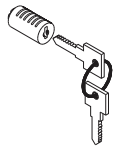

Notes

- Silver keyed alike lock cores should be specified when ordering Option E in the Lock Choice for Calibrate: No Lock w/ Silver Ring for Keyed Alike.
- Keyed alike lock cores must be installed in the field.
- Keys and Lock Cores are available in #'s 226 through 425.
- A core removal key is needed to remove an existing core from the lock housing in order to replace with a new core.
- Order sets based on quantity of storage items to be keyed alike.

BLACK LOCK CORES AND KEYS

Key Type	Model Number	List
Core with 2 keys	S-W1CORE1B	24
Core with 2 keys (set of 2 keyed alike)	S-W1CORE2B	37
Core with 2 keys (set of 3 keyed alike)	S-W1CORE3B	58
Core with 2 keys (set of 4 keyed alike)	S-W1CORE4B	74
Core with 2 keys (set of 5 keyed alike)	S-W1CORE5B	92
Core with 2 keys (set of 6 keyed alike)	S-W1CORE6B	107
Core with 2 keys (set of 7 keyed alike)	S-W1CORE7B	125
Core with 2 keys (set of 8 keyed alike)	S-W1CORE8B	144
Core with 2 keys (set of 9 keyed alike)	S-W1CORE9B	161
Core with 2 keys (set of 10 keyed alike)	S-W1CORE10B	178

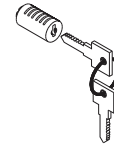

Notes

- Black keyed alike lock cores should be specified when ordering Option D in the Lock Choice for Calibrate: No Lock w/ Black Ring for Keyed Alike.
- Keyed alike lock cores must be installed in the field.
- Keys and Lock Cores are available in #'s 226 through 425.
- A core removal key is needed to remove an existing core from the lock housing in order to replace with a new core.
- Order sets based on quantity of storage items to be keyed alike.
- Black lock cores not available for L-Series storage.

REPLACEMENT PULLS

Type	Model Number	List
Bar Pull	X-BARHANDLE	32
L Pull	X-L-PULLHANDLE	32
Loop Pull	X-LOOPHANDLE	32
Rectangle Pull	X-RECTHANDLE	32

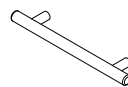

Bar Pull

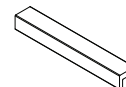

L Pull



Loop Pull

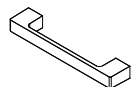

Rectangular Pull

Notes

- Replacements only.
- Pulls work for all metal and laminate storage units with the exception of roll out/ pantry towers.
- For replacement slim pulls, please contact Customer Service.

Keyboard Arms and Accessories

KEYBOARD ARM

Model Number	List
A-KEYBZ	709



EXTENDED KEYBOARD ARM

Model Number	List
A-KEYBZE	1,195

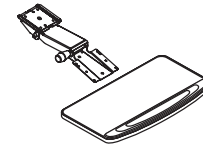

Notes

- Keyboard Arm mounts to underside of worksurfaces to support standard computer keyboards.
- Keyboard platform area behind wrist rest measures 8 1/2" deep x 20" wide.
- Keyboard tray include a factory mounted, synthetic leather wristrest.
- Keyboard arms are colored black.
- Order extended arm for use on all curvilinear corner worksurfaces except cockpit corners.
- Keyboard Arms may be mounted 90 degrees to the surface edge without the spacer but they will not be retractable.
- Oxygen Spacer required when used under a bench surface.

STANDARD MOUSE TRAY

Model Number	List
A-MSETS	211

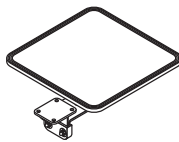

Notes

- Standard Mouse Tray mounts to either the left or right side of keyboard tray platform with screws to service both left and right handed users.
- Mouse area measures 7 1/4" x 7 1/4".
- Mouse tray swivels around vertical axis 270° and has 30° of tilt around the horizontal axis (15° above keyboard tray plane to 15° below plane, independent of keyboard tray tilt).
- The mouse tray is colored black.

OXYGEN SPACER

Quantity	Model Number	List
Single	O-OSPACER1	87
Double	O-OSPACER2	171
Triple	O-OSPACER3	254

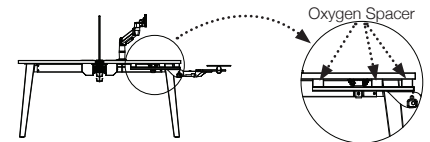
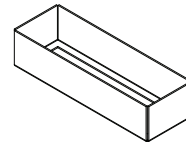

Notes

- Oxygen Spacer provides added height to keyboard arm and CPU holder tracks to allow them to install under Oxygen bench kits.
- Long screws for installation are included.
- Keyboard Arms may be mounted 90 degrees to the surface edge without the spacer but they will not be retractable.
- Available in black only.

V-Series Keyboard Arms

V-SERIES KEYBOARD ARM

Mouse Tray	Model Number	List
Fixed	A-KTOVSF	1,563
Adjustable	A-KTOVSA	1,660

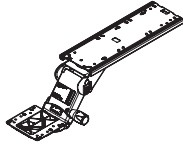

V-SERIES EXTENDED KEYBOARD ARM

Mouse Tray	Model Number	List
Adjustable	A-KTOVXA	1,797

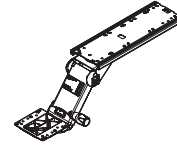

V-SERIES SIT-STAND KEYBOARD ARM

Mouse Tray	Model Number	List
Fixed	A-KTOVSSF	1,660
Adjustable	A-KTOVSSA	1,878

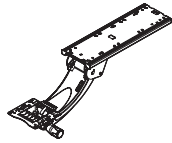

Notes

- V Series Keyboard Arms mount to the underside of worksurfaces to support computer keyboards.
- Arms may be specified with either a fixed or adjustable mouse tray, which may be installed on the left or right side of the keyboard tray.
- For detail of the adjustability range, see schematics.
- Keyboard Arms may be mounted 90° to the surface edge without the spacer but they will not be retractable.
- Standard Mouse Tray mounts to either the left or right side of keyboard tray platform with screws to service both left and right handed users.
- Mouse area measures 7 1/4" x 7 1/4".
- Mouse tray swivels around vertical axis 270° and has 30° of tilt around the horizontal axis (15° above keyboard tray plane to 15° below plane, independent of keyboard tray tilt).

EASY ACCESS CPU HOLDER

Mounting Type	Model	List
17.75" Track	A-CPUEA	1,153

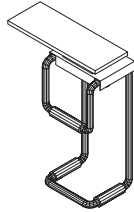

Notes

- Easy access CPU holder protects your CPU from damaging environmental factors by keeping it off the floor and out of the way.
- Glide tracks and 360° swivel mechanisms provide easy access to the back of the CPU.
- Vertically mounts to underside of worksurface.
- Swivels 360 degrees.
- No tools needed to adjust.
- The glide track is 17.75”.
- Adjustable width 2.5” - 8.25”.
- Adjustable height 13” - 21”.
- Load capacity is 100 lbs.
- Oxygen spacer required when used under a bench surface.

Power Data Solutions

ASHLEY UNO

Mounting Type	Model Number	List
Clamp	E-AUTCW	902
Under	E-AUUMW	902
Bezel	E-AUBMW	902

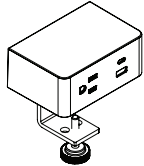

Clamp Mount

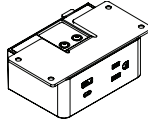

Under Mount

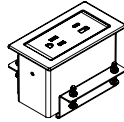

Bezel

Specify **Notes**

- Features one AC outlet for high-power devices, (1) USB-A and (1) USB-C port.
- Each USB port utilizes a Smart Device recognition Chip to monitor and deliver the required amperage to your devices.
- Available in white.
- The unit comes with a 6' cord and is available with surface, under or bezel mounting options.
- Fits in standard size grommets.
- Bezel mount requires special surface (2.12" x 4.45" hole size, 3/4" - 1 1/2" surface thickness).

ASHLEY DUO

Mounting Type	Model Number	List
Clamp	E-ADTCW	1,401
Under	E-ADUMW	1,401
Bezel	E-ADBMW	1,401

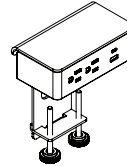

Clamp Mount

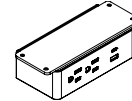

Under Mount

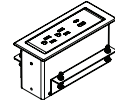

Bezel

Specify **Notes**

- Color (White/White or White/Silver)
- Features two AC outlets for high-power devices, (1) USB-A and (1) USB-C port.
- Each USB port utilizes a Smart Device Recognition chip to monitor and deliver the required amperage to your devices.
- The unit comes with a 72" cord option and is available with surface, under or bezel mounting options.
- Fits in standard size grommet.
- Bezel mount requires special surface (6" x 2.19" hole size, 1/2" - 1 1/2" surface thickness).

ASHLEY 202

Mounting Type	Model Number	List
Clamp	E-A202TCW	1,153
Under	E-A202UMW	1,153
Bezel	E-A202BMW	1,153

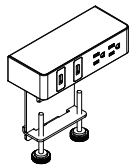

Clamp Mount

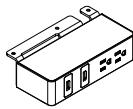

Under Mount

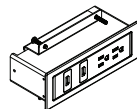

Bezel

Specify **Notes**

- Color (White/White or White/Silver)
- Features two AC outlets for high-power devices and two data inserts for your choice of the included blank insert or optional HDMI, RJ-45 or VGA inserts.
- The unit comes with a 72" cord and is available with surface, under or bezel mounting options.
- Bezel mount requires special surface (2.19" x 7.35" hole size, 3/4" - 1 1/2" surface thickness).

ASHLEY DUO AIR

Model Number	List
E-ADAP	1,436

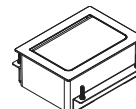

Closed

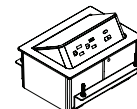

Open

Specify **Notes**

- Color (White or Silver)
- Features a pop-up cover that reveals an integrated wedge with two AC outlets and (1) USB-A and (1) USB-C port.
- Each USB port utilizes a Smart Device Recognition Chip to monitor and independently deliver the required amperage to your devices.
- The unit comes with a 72" cord.
- Ashley Duo Air requires special surface (4.63" x 6.75" hole size).

Power Data Solutions and Ganging Bolts

ASHLEY TRIO

Mounting Type	Model Number	List
Clamp	E-ATTCW	1,682
Under	E-ATUMW	1,237
Bezel	E-ATBMW	1,237

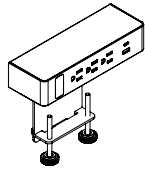

Clamp Mount

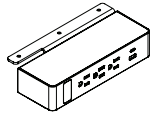

Under Mount

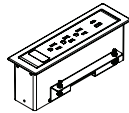

Bezel

Specify

- Color (White/White or White/Silver)

Notes

- Features three AC outlets for high-power devices, (1) USB-A and (1) USB-C port for optional HDMI, RJ-45, VGA or blank insert if desired.
- Each USB port utilizes a Smart Device Recognition Chip to monitor and independently deliver the required amperage for your devices.
- The unit comes with a 72" cord option and is available with surface, under or bezel mounting options.
- Bezel mount requires special surface (2.19" x 8.50" hole size, 3/4" - 1 1/2" surface thickness).

GANGING BOLT

Color	Model Number	List
Zinc-Plated	RH-98002A208	13

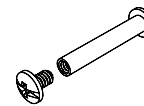

Notes

- Laminate Casegood Ganging Bolt gangs two laminate construction casegood units with standard 3/4" thick wall construction together by way of a field drilled 1/4" diameter hole.
- Combination drive style on both ends, 10-24 thread, adjusts from 1 1/2" to 1 5/8".

WORKSURFACE SUPPORT BRACKET

Model Number	List
O-WSLB	59
O-WSLBP	69

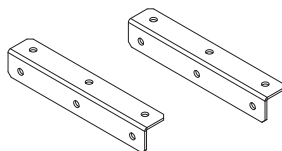

Specify

- Paint Selection

Notes

- Model number includes two brackets.
- Brackets measure 5.5" x 1" x 1".
- O-WSLB available in black only.
O-WSLBP available in any paint finish.



National Showrooms:

Leominster

AIS Headquarters
25 Tucker Drive
Leominster, MA 01453

Chicago

The Merchandise Mart
Suite 391
Chicago, Illinois 60654

New York

AIS New York
257 Park Avenue South
New York, New York 10010

Washington, D.C.

AIS Washington, D.C.
1501 M St, NW, STE 230
Washington, D.C. 20005

GSA Sales

GSA Contract 47QSM20D08Q4
Multiple Award Schedule (MAS)
Large Category: Furniture & Furnishings
Subcategories: Office Furniture, Packaged
Office Furniture and Furniture Services

For additional information on AIS:

Dealer Showrooms, Representative
Directory, Project Case Studies, Online
Catalog & Product Showcase
Visit: www.ais-inc.com