

Laminate End Panel Tables

(with Monitor Extension)

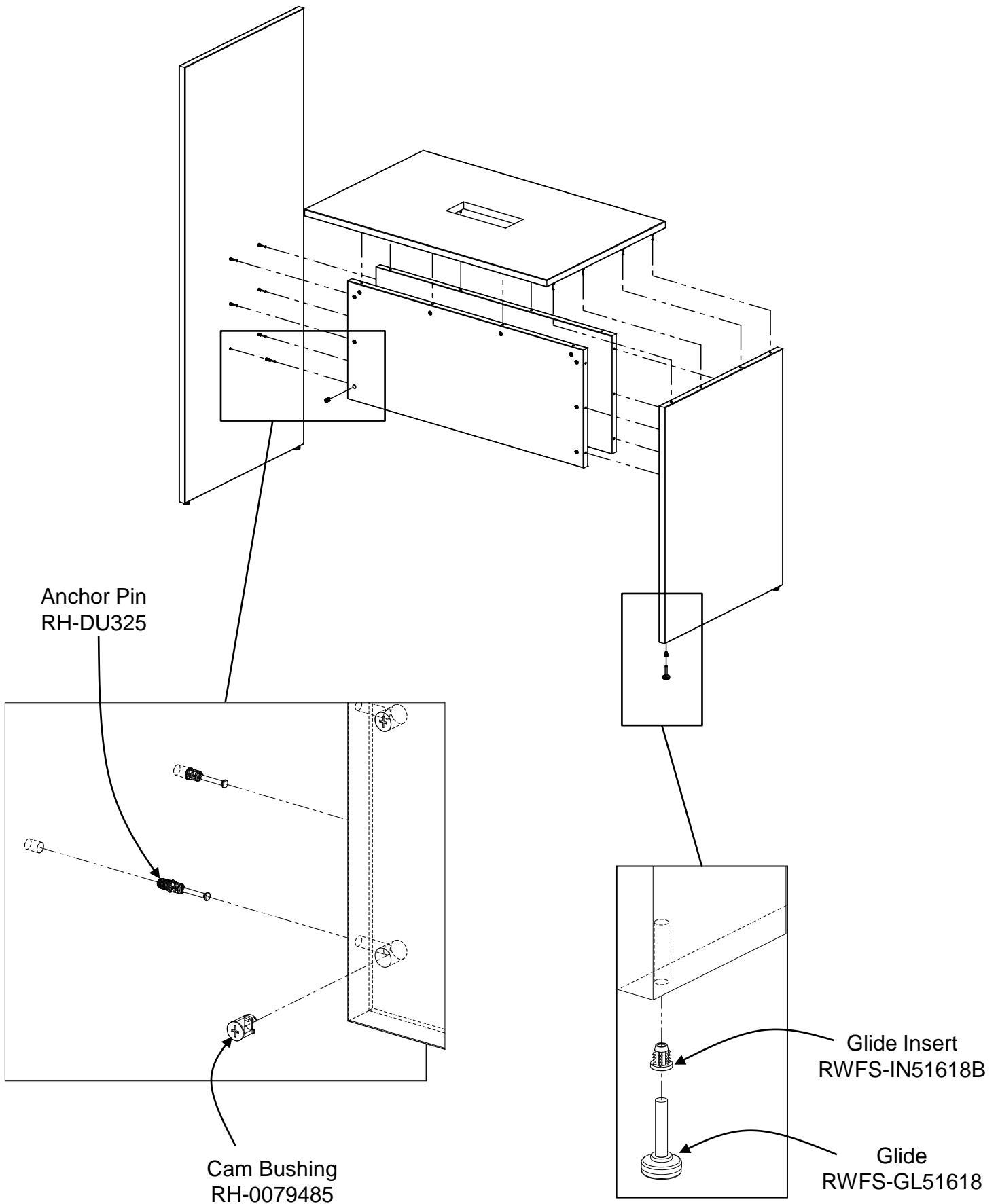

Laminate End Panel Tables

(with Monitor Extension)

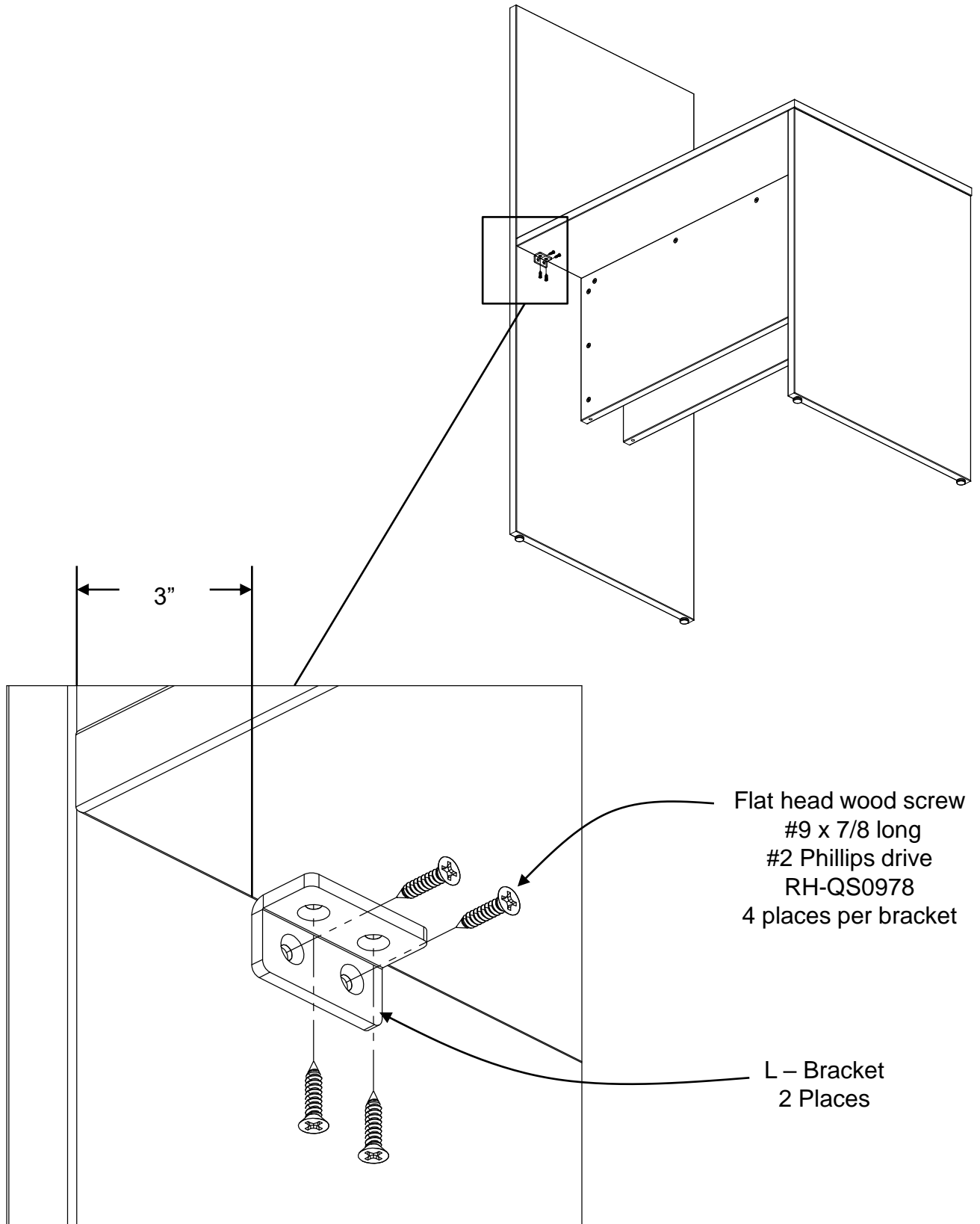

Laminate End Panel Tables

(with Lockers)

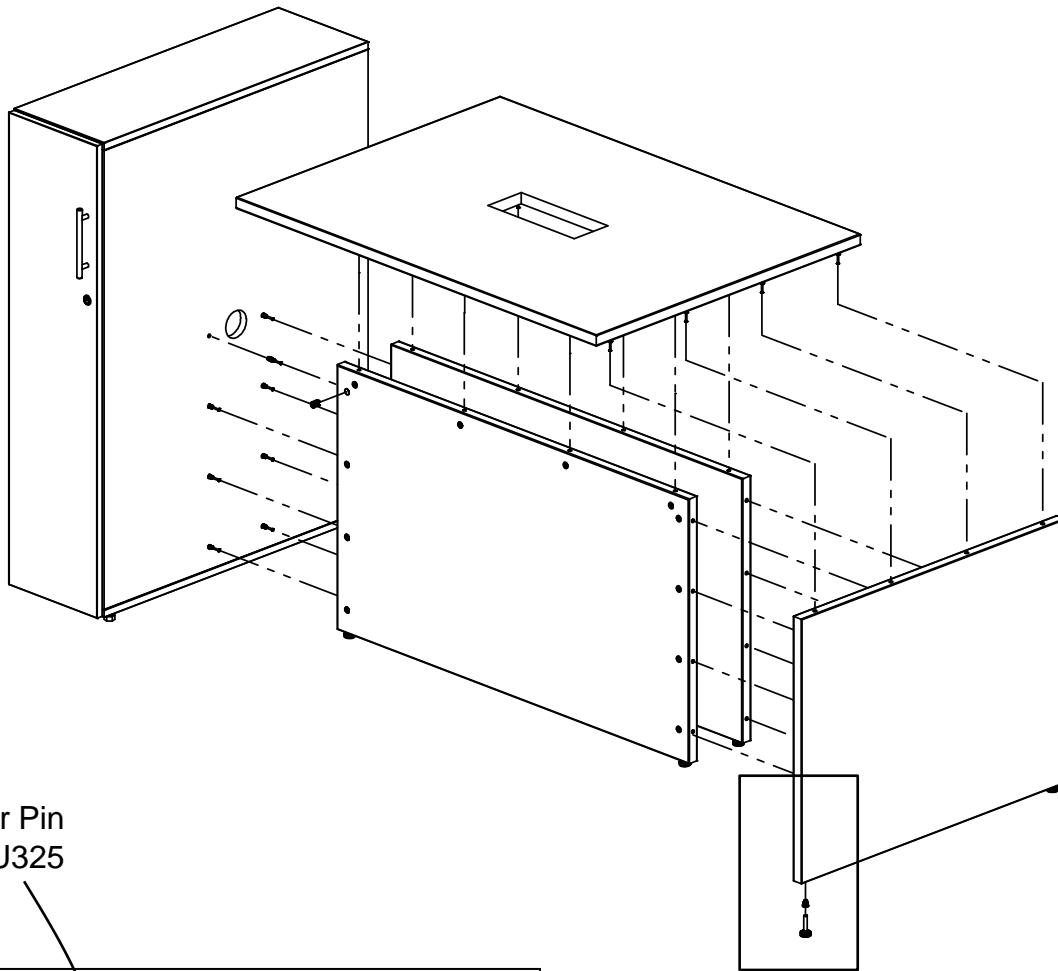

Anchor Pin
RH-DU325

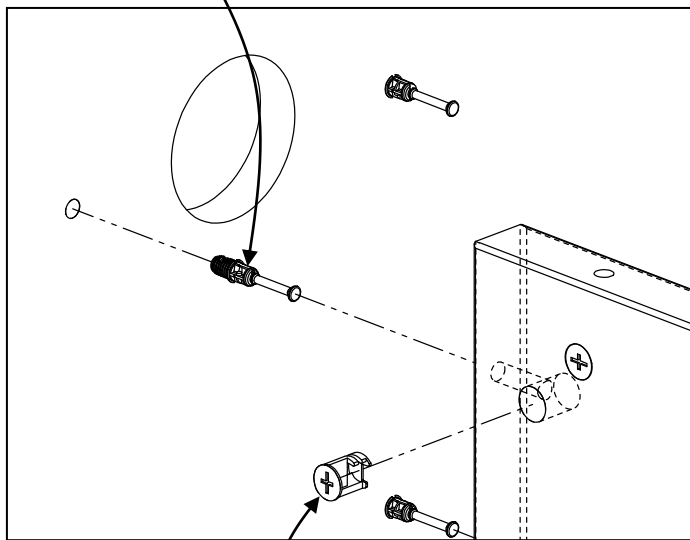

Cam Bushing
RH-0079485

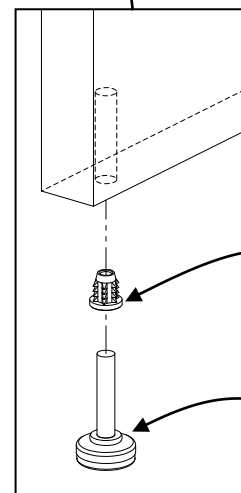

Glide Insert
RWFS-IN51618B

Glide
RWFS-GL51618

Laminate End Panel Tables

(with Lockers)

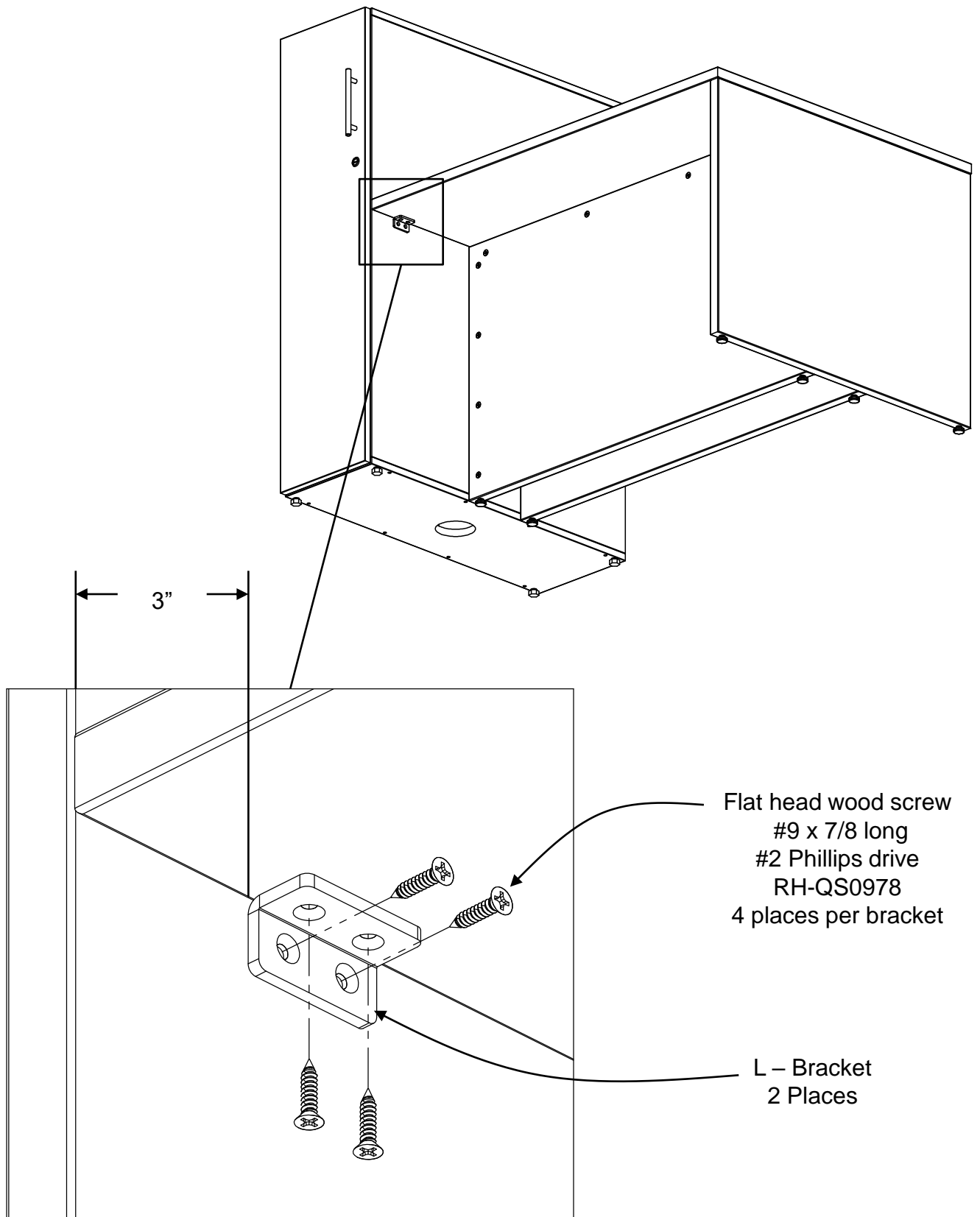

Laminate End Panel Tables

(Recessed and Flush)

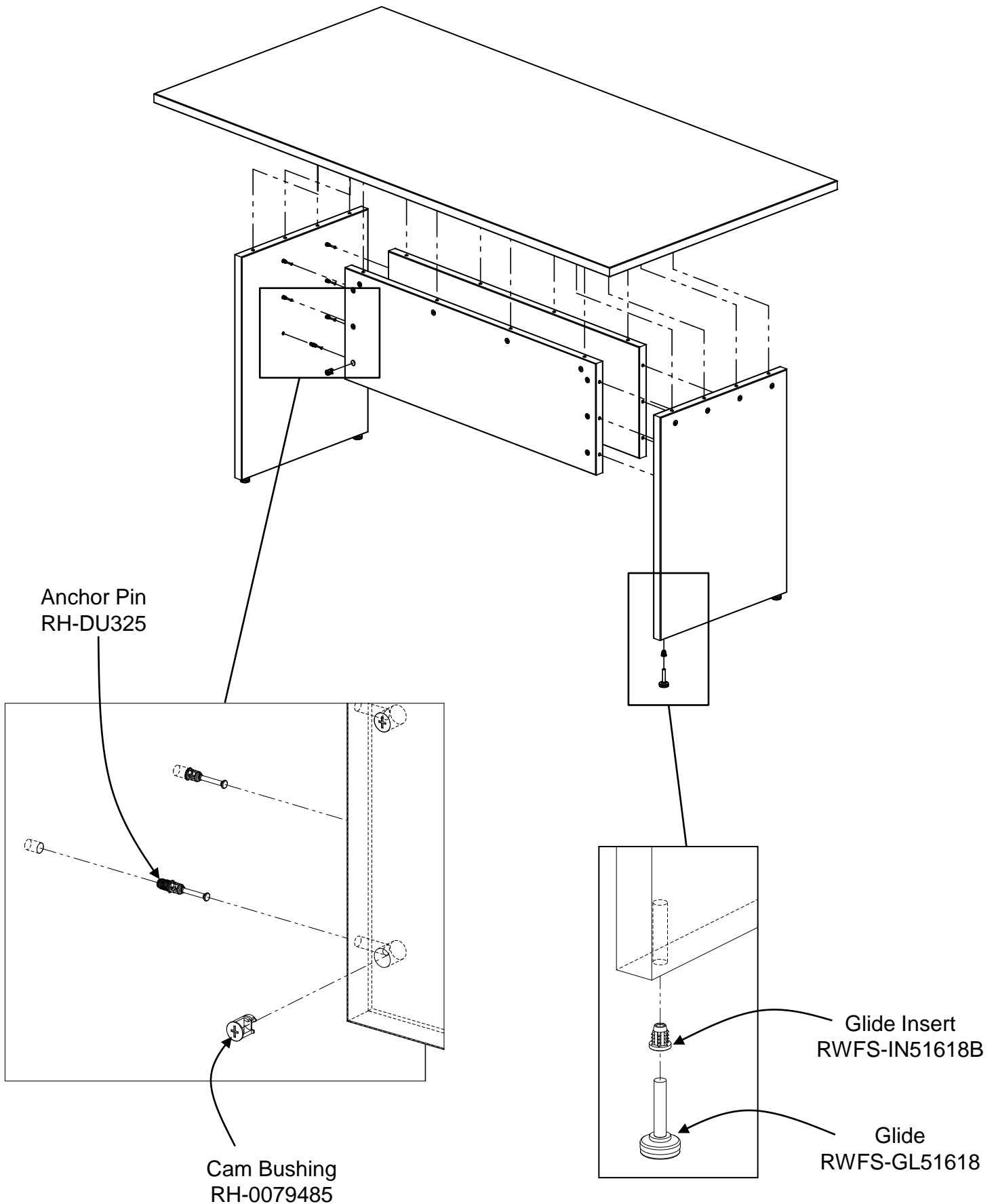

1. Install the Power Unit into the Box.

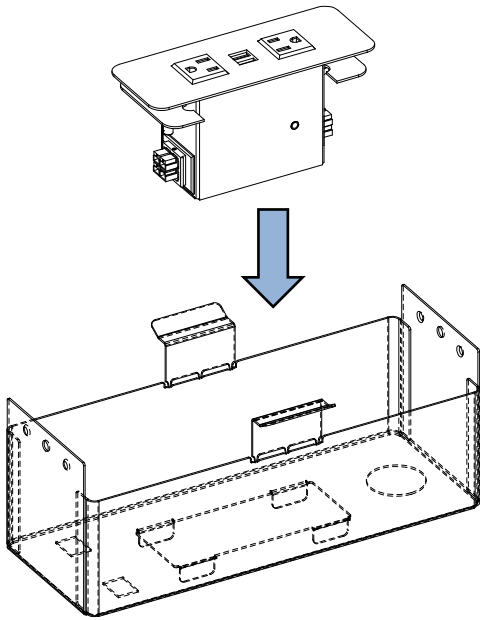

2. Install the Box into the worksurface.

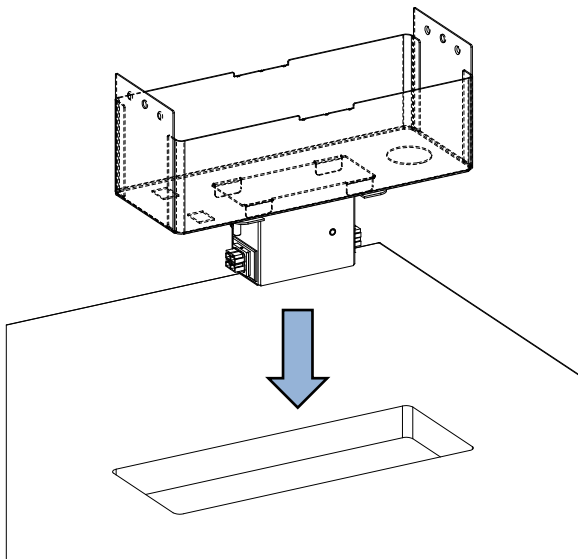

3a. Secure the Box to the worksurface using (4) #6 x 1" long flat head wood screw.

3b. Break off tabs off of box.

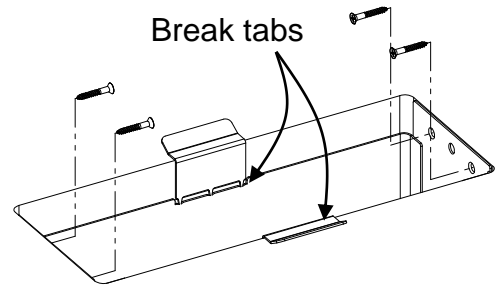

4. Install Cover.

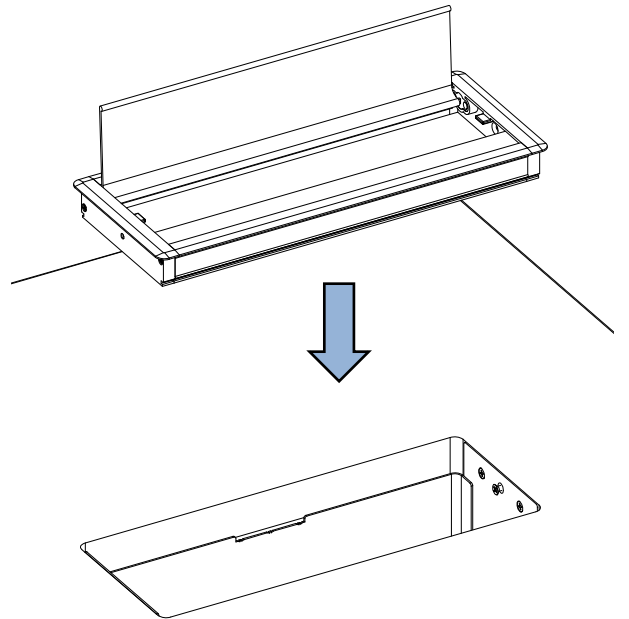

5. Secure Cover using (2) #6 x 1" long flat head wood screws

